

FIRETECH

HİDROLİK & PNÖMATİK FİYAT LİSTESİ

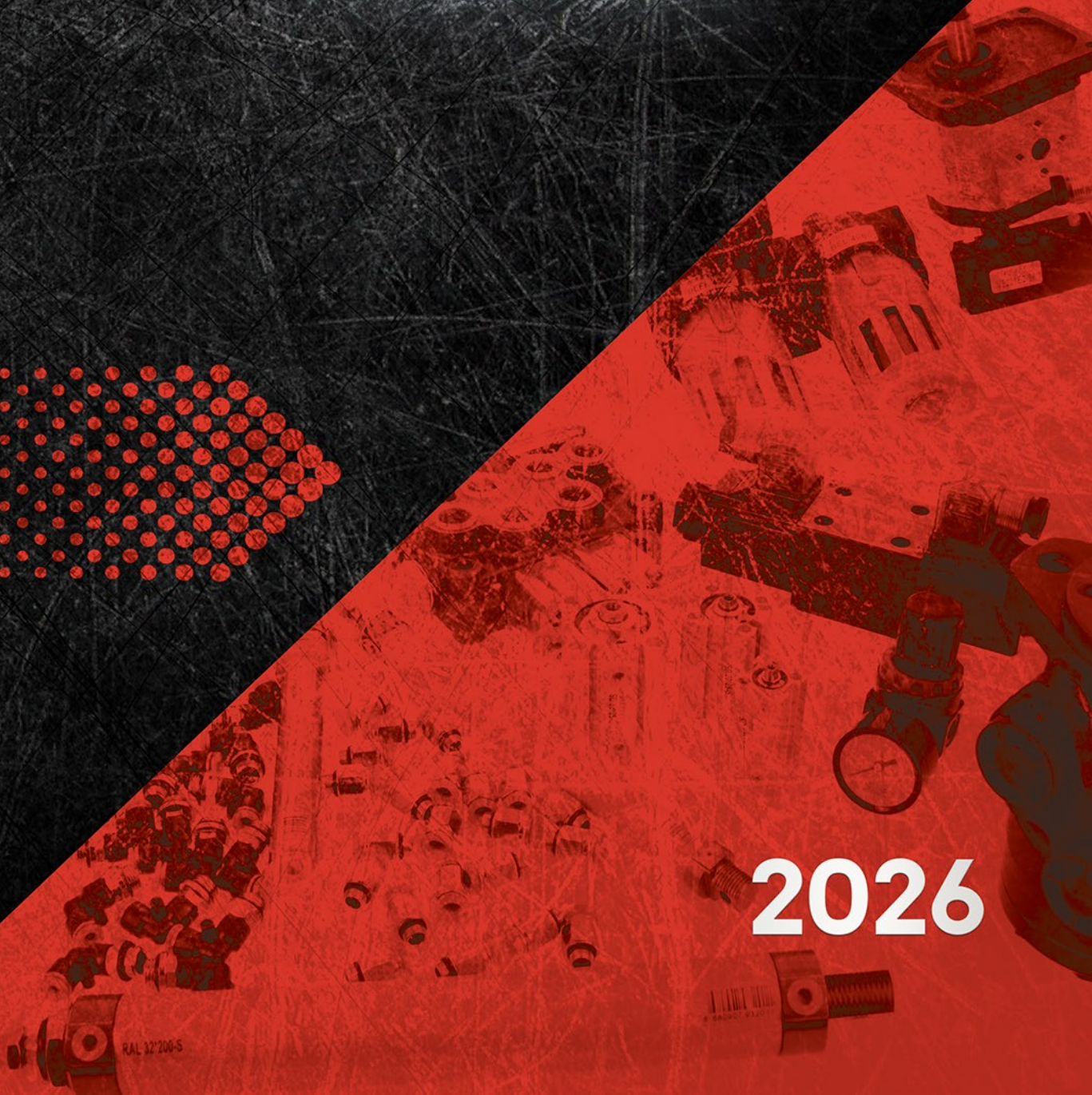

2026

RAL 32'200-S



Değerli iş ortaklarımız;

Ateş AŞ. olarak, sürekli gelişme ilkesi çerçevesinde yeni bir marka ve ürün grubuyla sizlerle tekrar buluşuyoruz; **FIRETECH** Hidrolik ve Pnömatik Malzemeler.

Hidrolik ve Pnömatik Malzemeler alanında **FIRETECH** markamız ile siz değerli iş ortaklarımızın ihtiyaçlarına optimum fiyat&kalite dengesine sahip çözümler üretebilmeyi amaçlıyoruz.

Hedefimiz bu alanda Türkiye'nin en geniş ürün çeşitliliğine, stok miktarına ve yaygınlığına sahip firması olabilmektir. Firmamızın 50 yıllık iş tecrübesini ve bu konudaki kararlılığımızı, profesyonel bir yönetim anlayışı ile birleştirerek hedeflerimize ulaşacağımıza inancımız tamdır.

Saygılarımızla
Ateş AŞ.

www.firetech.com.tr



HIDROOLI

PNEUMAT

Biz Kimiz?

Markalarımız bizim değerlerimizdir. Markalarımız yaşam felsefemizi yansıtır. ATEŞ bir çatı görevi görerek, evinde bir çok değerli markalar yetiştirir, korur ve geliştirir. Her bir markamız, aynı felsefe ve ideoloji ile geliştirilerek desteklenir. Bizim için önemli olan, tüketici sağlığı, ihtiyaçları ve mutluluğudur. İlkelerimizle birlikte kurumsallaşma yolunda güçlü ve sağlam adımlar atarak hareket ederiz. Firma ve markalarımız adına kararlar alırken, geçmişimizin tecrübeleri ve yarınlarımızın hedeflerini göz önüne alarak değerlendiririz.

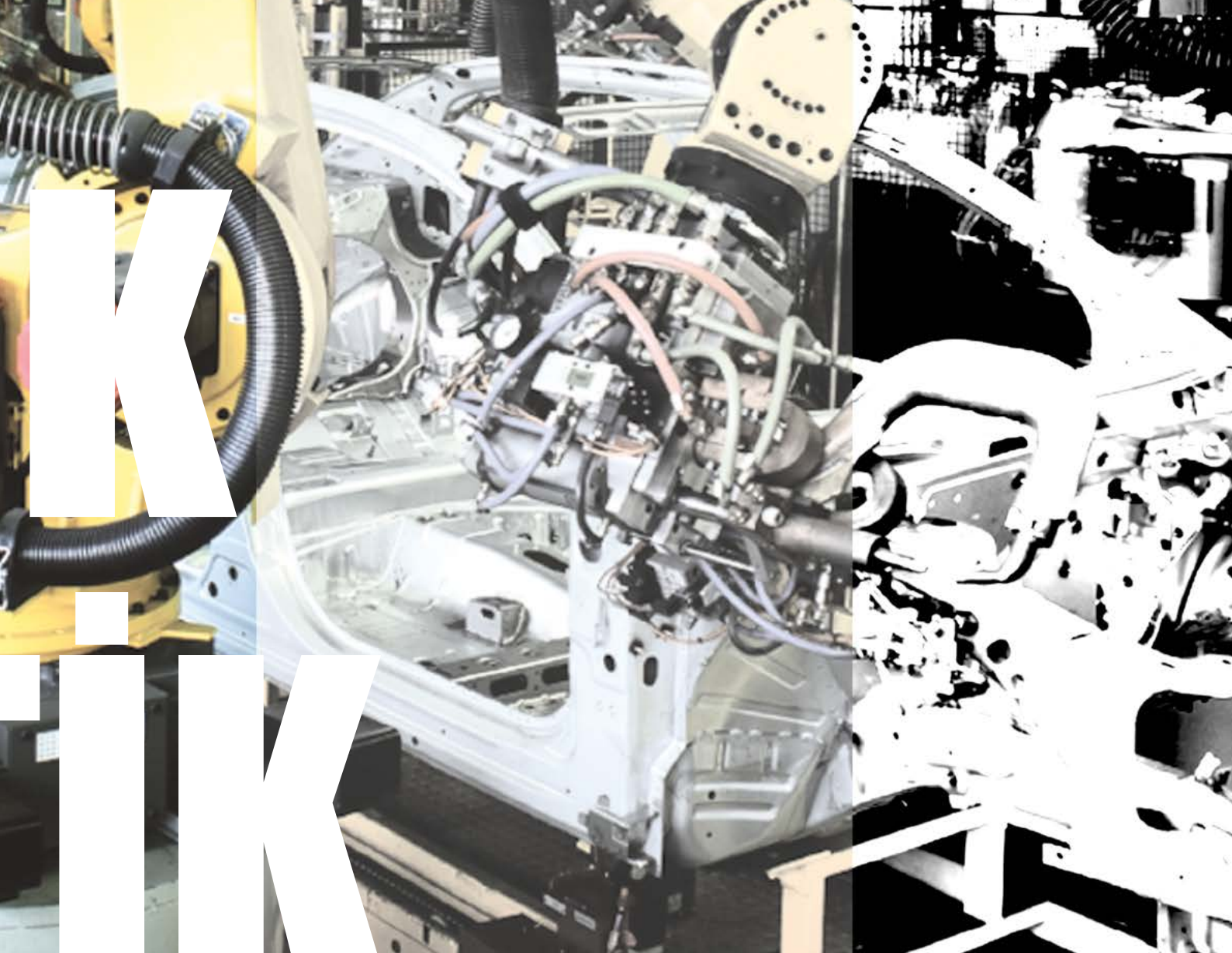

HİDROLİK



FIRETECH

NG6 Tek Bobin Valfler (Kırmızı Seri)



Şema	Kod	Açıklama	Fiyat (USD)
 * Kapalı geçişli	4WE6 D 24VDC	NG6 TEK BOBİN (KRM.ETK.) 4/2 TB – D24	89,90
	4WE6 D 220VAC	NG6 TEK BOBİN (KRM.ETK.) 4/2 TB – A220	
	4WE6 D 12VDC	NG6 TEK BOBİN (KRM.ETK.) 4/2 TB – D12	
	4WE6 D 110VAC	NG6 TEK BOBİN (KRM.ETK.) 4/2 TB – A110	

Şema	Kod	Açıklama	Fiyat (USD)
 * H geçişli	4WE6 HA 24VDC	NG6 TEK BOBİN (KRM.ETK.) 4/2 HM TB – D24	89,90
	4WE6 HA 220VAC	NG6 TEK BOBİN (KRM.ETK.) 4/2 HM TB – A220	
	4WE6 HA 12VDC	NG6 TEK BOBİN (KRM.ETK.) 4/2 HM TB – D12	
	4WE6 HA 110VAC	NG6 TEK BOBİN (KRM.ETK.) 4/2 HM TB – A110	

Şema	Kod	Açıklama	Fiyat (USD)
 * H geçişli	4WE6 C 24VDC	NG6 TEK BOBİN (KRM.ETK.) 4/2 H GEÇİŞLİ – D24	89,90
	4WE6 C 220VAC	NG6 TEK BOBİN (KRM.ETK.) 4/2 H GEÇİŞLİ – A220	
	4WE6 C 12VDC	NG6 TEK BOBİN (KRM.ETK.) 4/2 H GEÇİŞLİ – D12	
	4WE6 C 110VAC	NG6 TEK BOBİN (KRM.ETK.) 4/2 H GEÇİŞLİ – A110	

Max Çalışma Basıncı : 315 bar
Max Debi : 60 lt/dak(NG6)
Çalışma Sıcaklığı : -30 ~ 80 °C

NG6 Çift Bobin Valfler (Kırmızı Seri)



Şema	Kod	Açıklama	Fiyat (USD)
	4WE6 E 24VDC	NG6 ÇİFT BOBİN (KRM.ETK.) 4/3 KM – D24	124,90
	4WE6 E 220VAC	NG6 ÇİFT BOBİN (KRM.ETK.) 4/3 KM – A220	
	4WE6 E 12VDC	NG6 ÇİFT BOBİN (KRM.ETK.) 4/3 KM – D12	
	4WE6 E 110VAC	NG6 ÇİFT BOBİN (KRM.ETK.) 4/3 KM – A110	
	4WE6 H 24VDC	NG6 ÇİFT BOBİN (KRM.ETK.) 4/3 HM – D24	124,90
	4WE6 H 220VAC	NG6 ÇİFT BOBİN (KRM.ETK.) 4/3 HM – A220	
	4WE6 H 12VDC	NG6 ÇİFT BOBİN (KRM.ETK.) 4/3 HM – D12	
	4WE6 H 110VAC	NG6 ÇİFT BOBİN (KRM.ETK.) 4/3 HM – A110	
	4WE6 J 24VDC	NG6 ÇİFT BOBİN (KRM.ETK.) 4/3 ABT – D24	124,90
	4WE6 J 220VAC	NG6 ÇİFT BOBİN (KRM.ETK.) 4/3 ABT – A220	
	4WE6 J 12VDC	NG6 ÇİFT BOBİN (KRM.ETK.) 4/3 ABT – D12	
	4WE6 J 110VAC	NG6 ÇİFT BOBİN (KRM.ETK.) 4/3 ABT – A110	
	4WE6 G 24VDC	NG6 ÇİFT BOBİN (KRM.ETK.) 4/3 AM – D24	124,90
	4WE6 G 220VAC	NG6 ÇİFT BOBİN (KRM.ETK.) 4/3 AM – A220	
	4WE6 G 12VDC	NG6 ÇİFT BOBİN (KRM.ETK.) 4/3 AM – D12	
	4WE6 G 110VAC	NG6 ÇİFT BOBİN (KRM.ETK.) 4/3 AM – A110	
	4WE6 D/OF 24VDC	NG6 ÇİFT BOBİN (KRM.ETK.) 4/3 DETANTLI – D24	133,80
	4WE6 D/OF 110VAC	NG6 ÇİFT BOBİN (KRM.ETK.) 4/3 DETANTLI – A110	
	4WE6 D/OF 220VAC	NG6 ÇİFT BOBİN (KRM.ETK.) 4/3 DETANTLI – A220	

Max Çalışma Basıncı : 315 bar
 Max Debi : 60 lt/dak(NG6)
 Çalışma Sıcaklığı : -30 ~ 80 °C

NG10 Tek Bobin Valfler (Kırmızı Seri)

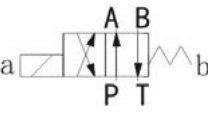

Şema	Kod	Açıklama	Fiyat (USD)
 * Kapalı geçişli	4WE10 D 24VDC	NG10 TEK BOBİN (KRM.ETK.) 4/2 TB – D24	149,80
	4WE10 D 220VAC	NG10 TEK BOBİN (KRM.ETK.) 4/2 TB – A220	
	4WE10 D 12VDC	NG10 TEK BOBİN (KRM.ETK.) 4/2 TB – D12	

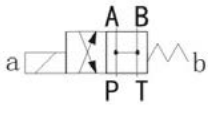
Şema	Kod	Açıklama	Fiyat (USD)
 * H geçişli	4WE10 HA 24VDC	NG10 TEK BOBİN (KRM.ETK.) 4/2 HM TB – D24	149,80
	4WE10 HA 220VAC	NG10 TEK BOBİN (KRM.ETK.) 4/2 HM TB – A220	
	4WE10 HA 12VDC	NG10 TEK BOBİN (KRM.ETK.) 4/2 HM TB – D12	

Şema	Kod	Açıklama	Fiyat (USD)
 * H geçişli	4WE10 C 24VDC	NG10 TEK BOBİN (KRM.ETK.) 4/2 H GEÇİŞLİ – D24	149,80
	4WE10 C 220VAC	NG10 TEK BOBİN (KRM.ETK.) 4/2 H GEÇİŞLİ – A220	
	4WE10 C 12VDC	NG10 TEK BOBİN (KRM.ETK.) 4/2 H GEÇİŞLİ – D12	

Max Çalışma Basıncı : 315 bar
Max Debi : 120 lt/dak(NG6)
Çalışma Sıcaklığı : -30 ~ 80 °C

NG10 Çift Bobin Valfler (Kırmızı Seri)



Şema	Kod	Açıklama	Fiyat (USD)
	4WE10 E 24VDC	NG10 ÇİFT BOBİN (KRM.ETK.) 4/3 KM – D24	212,90
	4WE10 E 220VAC	NG10 ÇİFT BOBİN (KRM.ETK.) 4/3 KM – A220	
	4WE10 E 12VDC	NG10 ÇİFT BOBİN (KRM.ETK.) 4/3 KM – D12	

Şema	Kod	Açıklama	Fiyat (USD)
	4WE10 H 24VDC	NG10 ÇİFT BOBİN (KRM.ETK.) 4/3 HM – D24	212,90
	4WE10 H 220VAC	NG10 ÇİFT BOBİN (KRM.ETK.) 4/3 HM – A220	
	4WE10 H 12VDC	NG10 ÇİFT BOBİN (KRM.ETK.) 4/3 HM – D12	

Şema	Kod	Açıklama	Fiyat (USD)
	4WE10 J 24VDC	NG10 ÇİFT BOBİN (KRM.ETK.) 4/3 ABT – D24	212,90
	4WE10 J 220VAC	NG10 ÇİFT BOBİN (KRM.ETK.) 4/3 ABT – A220	
	4WE10 J 12VDC	NG10 ÇİFT BOBİN (KRM.ETK.) 4/3 ABT – D12	

Şema	Kod	Açıklama	Fiyat (USD)
	4WE10 G 24VDC	NG10 ÇİFT BOBİN (KRM.ETK.) 4/3 AM – D24	212,90
	4WE10 G 220VAC	NG10 ÇİFT BOBİN (KRM.ETK.) 4/3 AM – A220	
	4WE10 G 12VDC	NG10 ÇİFT BOBİN (KRM.ETK.) 4/3 AM – D12	

Max Çalışma Basıncı : 315 bar
Max Debi : 120 lt/dak(NG6)
Çalışma Sıcaklığı : -30 ~ 80 °C

NG16 Yön Denetim Valfleri (Kırmızı Seri)



Şema	Kod	Açıklama	Fiyat (USD)
	4WEH16 D 6X/ET	NG16 GÖVDE 4/2 (KRM.ETK.) - TB	253,00
	4WEH16 E 6X/ET	NG16 GÖVDE 4/3 (KRM.ETK.) - KM	253,00
	4WEH16 H 6X/ET	NG16 GÖVDE 4/3 (KRM.ETK.) - HM	253,00
	4WEH16 J 6X/ET	NG16 GÖVDE 4/3 (KRM.ETK.) - ABT	253,00
	4WEH16 G 6X/ET	NG16 GÖVDE 4/3 (KRM.ETK.) - AM	253,00
		NG16 ÖN GERİLİM VALFİ, 4.5bar (VORSPANN)	53,60

* Pilot valfi ve ön gerilim valfi fiyatlara dahil değildir, haricen sipariş verilmelidir

** Valfler; dahili pilot ve dahili sızıntılıdır

*** HM ve AM sürgülü valfler için, dahili pilot uygulamalarında ön gerilim valfi kullanılması tavsiye edilir.

NG25 Yön Denetim Valfleri (Kırmızı Seri)



Şema	Kod	Açıklama	Fiyat (USD)
	4WEH25 D 6X/ET	NG25 GÖVDE 4/2 (KRM.ETK.) - TB	425,80
	4WEH25 E 6X/ET	NG25 GÖVDE 4/3 (KRM.ETK.) - KM	425,80
	4WEH25 H 6X/ET	NG25 GÖVDE 4/3 (KRM.ETK.) - HM	425,80
	4WEH25 J 6X/ET	NG25 GÖVDE 4/3 (KRM.ETK.) - ABT	425,80
	4WEH25 G 6X/ET	NG25 GÖVDE 4/3 (KRM.ETK.) - AM	425,80
		NG25 ÖN GERİLİM VALFİ, 4.5bar (VORSPANN)	60,20

* Pilot valfi ve ön gerilim valfi fiyatlara dahil değildir, haricen sipariş verilmelidir

** Valfler; dahili pilot ve dahili sızıntılıdır

*** HM ve AM sürgülü valfler için, dahili pilot uygulamalarında ön gerilim valfi kullanılması tavsiye edilir.

NG32 Yön Denetim Valfleri (Kırmızı Seri)

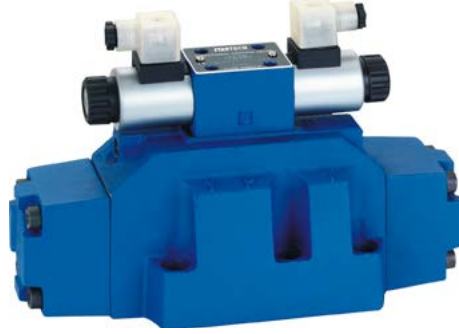

Şema	Kod	Açıklama	Fiyat (USD)
	4WEH32 D 6X/ET	NG32 GÖVDE 4/2 (KRM.ETK.) - TB	1.330,30
	4WEH32 E 6X/ET	NG32 GÖVDE 4/3 (KRM.ETK.) - KM	1.330,30
	4WEH32 H 6X/ET	NG32 GÖVDE 4/3 (KRM.ETK.) - HM	1.330,30
	4WEH32 J 6X/ET	NG32 GÖVDE 4/3 (KRM.ETK.) - ABT	1.330,30
	4WEH32 G 6X/ET	NG32 GÖVDE 4/3 (KRM.ETK.) - AM	1330,30
		NG32 ÖN GERİLİM VALFİ, 4.5bar (VORSPANN)	86,20

* Pilot valfi ve ön gerilim valfi fiyatlara dahil değildir, haricen sipariş verilmelidir

** Valfler; dahili pilot ve dahili sızıntılıdır

*** HM ve AM sürgülü valfler için, dahili pilot uygulamalarında ön gerilim valfi kullanılması tavsiye edilir.

Mekanik Uyarılı (Kollu) Yön Denetim Valfleri (Kırmızı Seri)



Şema	Kod	Açıklama	Fiyat (USD)
	4WMM6 D 80	NG6 KOLLU VALF (KRM.ETK.) 4/2 TB	129,90
	4WMM6 E 80	NG6 KOLLU VALF (KRM.ETK.) 4/3 KM	129,90
	4WMM6 H 80	NG6 KOLLU VALF (KRM.ETK.) 4/3 HM	129,90
	4WMM6 J 80	NG6 KOLLU VALF (KRM.ETK.) 4/3 ABT	129,90
	4WMM6 G 80	NG6 KOLLU VALF (KRM.ETK.) 4/3 AM	129,90
	4WMM6 D 80 F	NG6 KOLLU VALF (KRM.ETK.) 4/2 TB - DETANTLI	129,90
	4WMM6 E 80 F	NG6 KOLLU VALF (KRM.ETK.) 4/3 KM - DETANTLI	129,90
	4WMM6 H 80 F	NG6 KOLLU VALF (KRM.ETK.) 4/3 HM - DETANTLI	129,90
	4WMM6 J 80 F	NG6 KOLLU VALF (KRM.ETK.) 4/3 ABT - DETANTLI	129,90
	4WMM6 G 80 F	NG6 KOLLU VALF (KRM.ETK.) 4/3 AM - DETANTLI	129,90

Max Çalışma Basıncı : 315 bar
Max Debi : 60 lt/dak(NG6)
Çalışma Sıcaklığı : -30 ~ 80 °C

Mekanik Uyarılı (Kollu) Yön Denetim Valfleri (Kırmızı Seri)



Şema	Kod	Açıklama	Fiyat (USD)
	4WMM10 D 80	NG10 KOLLU VALF (KRM.ETK.) 4/2 TB	171,50
	4WMM10 E 80	NG10 KOLLU VALF (KRM.ETK.) 4/3 KM	171,50
	4WMM10 H 80	NG10 KOLLU VALF (KRM.ETK.) 4/3 HM	171,50
	4WMM10 J 80	NG10 KOLLU VALF (KRM.ETK.) 4/3 ABT	171,50
	4WMM10 G 80	NG10 KOLLU VALF (KRM.ETK.) 4/3 AM	171,50
	4WMM10 D 80 F	NG10 KOLLU VALF (KRM.ETK.) 4/2 TB - DETANTLI	171,50
	4WMM10 E 80 F	NG10 KOLLU VALF (KRM.ETK.) 4/3 KM - DETANTLI	171,50
	4WMM10 H 80 F	NG10 KOLLU VALF (KRM.ETK.) 4/3 HM - DETANTLI	171,50
	4WMM10 J 80 F	NG10 KOLLU VALF (KRM.ETK.) 4/3 ABT - DETANTLI	171,50
	4WMM10 G 80 F	NG10 KOLLU VALF (KRM.ETK.) 4/3 AM - DETANTLI	171,50

Max Çalışma Basıncı : 315 bar

Max Debi : 120 lt

Valf Aksesuarları (Kırmızı Seri)



Stok Kodu	"Ölçü (İç ÇapxBoy)"	Açıklama	Fiyat (USD)
Z8-60 YC 12V	Ø23,2 x 50,6 mm	NG6 BOBİN 12VDC (KRM.ETK.)	25,30
Z8-60 YC 24V	Ø23,2 x 50,6 mm	NG6 BOBİN 24VDC (KRM.ETK.)	25,30
B8-60 YC 110V	Ø23,2 x 50,6 mm	NG6 BOBİN 110VAC (KRM.ETK.)	25,30
B8-60 YC 220V	Ø23,2 x 50,6 mm	NG6 BOBİN 220VAC (KRM.ETK.)	25,30
Z8-120 YC 12V	Ø31,6 x 75 mm	NG10 BOBİN 12VDC (KRM.ETK.)	45,70
Z8-120 YC 24V	Ø31,6 x 75 mm	NG10 BOBİN 24VDC (KRM.ETK.)	45,70
B8-120 YC 110V	Ø31,6 x 75 mm	NG10 BOBİN 110VAC (KRM.ETK.)	45,70
B8-120 YC 220V	Ø31,6 x 75 mm	NG10 BOBİN 220VAC (KRM.ETK.)	45,70
CONNECTOR-DC	-	İŞIKLI SOKET DC	4,60
CONNECTOR-AC	-	İŞIKLI SOKET AC	4,60

Modüler Kilit Valfleri (Kırmızı Seri)

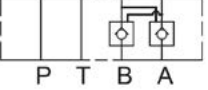

Şema	Kod	Açıklama	Fiyat (USD)
	Z2S-6	KİLİT VALF NG6 AB HATTI (KRM.ETK.)	69,90
	Z2S-10	KİLİT VALF NG10 AB HATTI (KRM.ETK.)	112,00

Modüler Debi Ayar Valfleri (Kırmızı Seri)

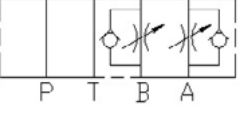

Şema	Kod	Açıklama	Fiyat (USD)
	Z2FS-6	DEBİ AYAR VALF NG6 AB HATTI (KRM.ETK.)	69,90
	Z2FS-10	DEBİ AYAR VALF NG10 AB HATTI (KRM.ETK.)	112,00
	MTCV 02	HIZ AYAR VALFİ, İKİZ, NG6, VOLANLI (KRM.ETK.)	69,90
	MTCV 03	HIZ AYAR VALFİ, İKİZ, NG10, VOLANLI (KRM.ETK.)	112,00

Modüler Basınç Emniyet Valfleri (Kırmızı Seri)



Şema	Kod	Açıklama	Fiyat (USD)
	ZDB6 VP1	BASINÇ EMNİYET VALFİ NG6 P HATTI (KRM.ETK.)	186,60
	ZDB10 VP1	BASINÇ EMNİYET VALFİ NG10 P HATTI (KRM.ETK.)	288,00

Modüler Basınç Düşürücü Valfler (Kırmızı Seri)

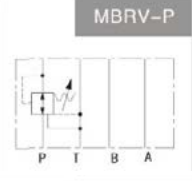
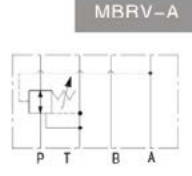

Şema	Kod	Açıklama	Fiyat (USD)
	MBRV 02 PK 3	BASINÇ DÜŞÜRÜCÜ NG6 P HATTI (KRM.ETK.)	66,90
	MBRV 02 AK 3	BASINÇ DÜŞÜRÜCÜ NG6 A HATTI (KRM.ETK.)	66,90
	MBRV 03 PK 3	BASINÇ DÜŞÜRÜCÜ NG10 P HATTI (KRM.ETK.)	113,70

Max Çalışma Basıncı : 315 bar

Direk Uyarılı Emniyet Valfleri (Kırmızı Seri)

Kartuş Tip Direk Uyarılı Emniyet Valfi (Kırmızı Seri)

Şema	Kod	Açıklama	Fiyat (USD)
	DBDH 6K-10/100	BASINÇ EMNİYET VALFİ, KARTUŞ TİP, 100bar	107,60
	DBDH 6K-10/315	BASINÇ EMNİYET VALFİ, KARTUŞ TİP, 315bar	107,60
	DBDH 10K-10/100	BASINÇ EMNİYET VALFİ, KARTUŞ TİP, 100bar	114,70
	DBDH 10K-10/315	BASINÇ EMNİYET VALFİ, KARTUŞ TİP, 315bar	114,70
	DBDS 20K-10/315	BASINÇ EMNİYET VALFİ, KARTUŞ TİP, 100bar	120,80
	DBDS 30K-10/315	BASINÇ EMNİYET VALFİ, KARTUŞ TİP, 315bar	200,90

Hat Tipi Basınç Emniyet Valfi (Kırmızı Seri)

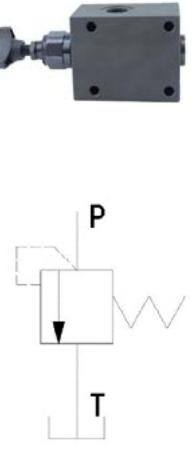
Şema	Kod	Açıklama	Fiyat (USD)
	DBDH 6G-10/100	BASINÇ EMNİYET VALFİ, HAT TİPİ, G1/4, 100 bar	139,90
	DBDH 6G-10/315	BASINÇ EMNİYET VALFİ, HAT TİPİ, G1/4, 315 bar	139,90
	DBDH 10G-10/100	BASINÇ EMNİYET VALFİ, HAT TİPİ, G3/8, 100 bar	187,50
	DBDH 10G-10/315	BASINÇ EMNİYET VALFİ, HAT TİPİ, G3/8, 315 bar	187,50
	DBDS 20G-10/315	BASINÇ EMNİYET VALFİ, HAT TİPİ, G1, 315 bar	162,90
	DBDS 30G-10/315	BASINÇ EMNİYET VALFİ, HAT TİPİ, G1 1/2, 315 bar	385,30

Not: Ayar basınç aralığı 7 ~ 210 bar'dır

Pleyt Tipi, Pilot Uyarılı Emniyet Valfler (Kırmızı Seri)

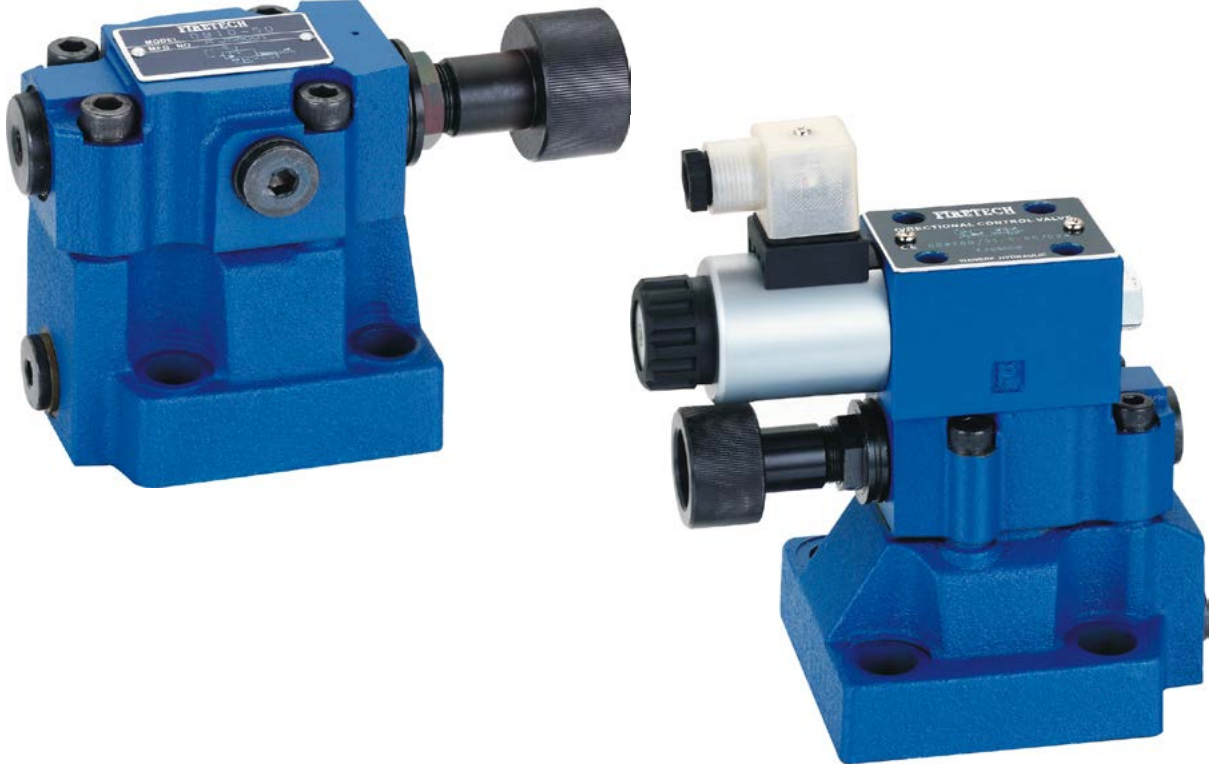

Şema	Kod	Açıklama	Fiyat (USD)
	DB 10	BASINÇ AYAR NG16 MANUEL	153,80
	DB 20	BASINÇ AYAR NG25 MANUEL	173,80
	DB 30	BASINÇ AYAR NG32 MANUEL	200,50
	DBW 10 B1	SIFIRLAMALI TİP BASINÇ AYAR NG16 - 24VDC **	247,30
	DBW 20 B1	SIFIRLAMALI TİP BASINÇ AYAR NG25 - 24VDC **	274,20
	DBW 30 B1	SIFIRLAMALI TİP BASINÇ AYAR NG32 - 24VDC **	285,30

Not: Azami ayar basıncı 315 bar'dır

** Pilot valfi fiyata dahil olup montajlı olarak teslim edilir.

Çekli Hız Ayar Valfi



Şema	Kod	Açıklama	Fiyat (USD)
	STU-04	ÇEKİLİ HIZ AYAR VALFİ 1/4"	77,80
	STU-06	ÇEKİLİ HIZ AYAR VALFİ 3/8"	84,80
	STU-08	ÇEKİLİ HIZ AYAR VALFİ 1/2"	105,20
	STU-12	ÇEKİLİ HIZ AYAR VALFİ 3/4"	120,90
	STU-16	ÇEKİLİ HIZ AYAR VALFİ 1"	169,60

Çeksiz Hız Ayar Valfi (İğne Vana)



Şema	Kod	Açıklama	Fiyat (USD)
	STB-04	ÇEKSİZ HIZ AYAR VALFİ 1/4"	64,40
	STB-06	ÇEKSİZ HIZ AYAR VALFİ 3/8"	81,70
	STB-08	ÇEKSİZ HIZ AYAR VALFİ 1/2"	92,70
	STB-12	ÇEKSİZ HIZ AYAR VALFİ 3/4"	114,70
	STB-16	ÇEKSİZ HIZ AYAR VALFİ 1"	158,60

Hat Tipi Çekvalf

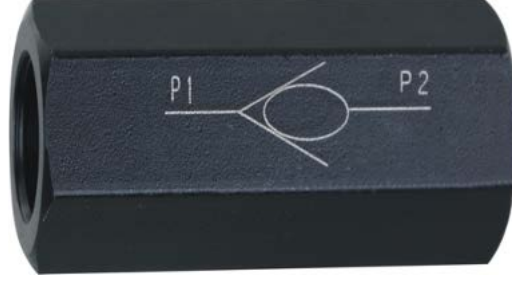

Şema	Kod	Açıklama	Fiyat (USD)
	S6A1	HAT TİPİ ÇEKVALF - G1/4	20,30
	S8A1	HAT TİPİ ÇEKVALF - G3/8	21,90
	S10A1	HAT TİPİ ÇEKVALF - G1/2	26,60
	S15A1	HAT TİPİ ÇEKVALF - G3/4	29,70
	S20A1	HAT TİPİ ÇEKVALF - G1	45,40

Boru Tip Çekli Hız Ayar Valfi



Şema	Kod	Açıklama	Fiyat (USD)
	MK 6 G-1X/V	BORU TİP ÇEKİLİ HIZ AYAR VALFİ G1/4	83,30
	MK 8 G-1X/V	BORU TİP ÇEKİLİ HIZ AYAR VALFİ G3/8	95,20
	MK 10 G-1X/V	BORU TİP ÇEKİLİ HIZ AYAR VALFİ G1/2	106,50
	MK 15 G-1X/V	BORU TİP ÇEKİLİ HIZ AYAR VALFİ G3/4	121,70
	MK 20 G-1X/V	BORU TİP ÇEKİLİ HIZ AYAR VALFİ G1	147,20

Hassas Hız Ayar Valfi (Kırmızı Seri)



Şema	Kod	Açıklama	Fiyat (USD)
	2FRM 5	HASSAS HIZ AYAR VALFİ, 0.2 lt/dak	367,70
	2FRM 6	HASSAS HIZ AYAR VALFİ, 6 lt/dak	367,70

Max Çalışma Basıncı : 315 bar

Oransal Basınç ve Debi Kontrol Valfleri



Şema	Kod	Açıklama	Fiyat (USD)
	ER-G01-3-10	ORANSAL PİLOT BASINÇ SINIRLAMA VALFİ NG6	384,90
	ER-G03-3-10	ORANSAL BASINÇ SINIRLAMA VALFİ NG10	664,90
	ER-G06-3-10	ORANSAL BASINÇ SINIRLAMA VALFİ NG25	694,90
	ER-G10-3-10	ORANSAL BASINÇ SINIRLAMA VALFİ NG32	1.029,90
	EFBG-03-125-H	ORANSAL P-Q VALFİ NG10 (40 Ohm-10 Ohm)	640,00
	EFBG-06-250-H	ORANSAL P-Q VALFİ NG25 (40 Ohm-10 Ohm)	1.150,00

Oransal Valf Kartları



Kod	Açıklama	Fiyat (USD)
ADF11-A-D2-3-40	ORANSAL VALF KARTI 0-10VDC (SOKET TİPİ)	344,70
ADE-11-A-01-D2-3-40	ORANSAL V.KARTI, TEK ÇIKIŞ 0-10VDC (PANO TİPİ)	342,80
ADE-11-A-02-D2-3-40	ORANSAL V.KARTI, ÇİFT ÇIKIŞ 0-10VDC (PANO TİPİ)	532,30

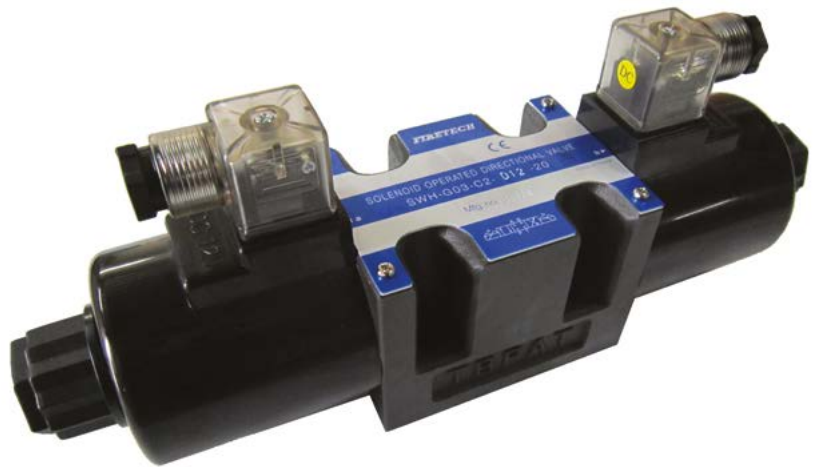

Kumanda Kolları

YENİ SERİ



TİP	Debi	Kol Sayısı	PORT ÖLÇÜLERİ Tüm Portlar	Fiyat (USD)
1P40	40 lt/dak	TEKLİ	1/2"	92,70
2P40		İKİLİ		142,60
3P40		ÜÇLÜ		193,50
4P40		DÖRTLÜ		240,10
5P40		BEŞLİ		310,10
6P40		ALTILI		379,50
P40 - CARRY OVER (1/2")				11,00
P40 - DETANT KİT				31,10
P40 - KOL KAPAĞI				19,80
P40 - ARKA KAPAK				5,90
P40 - SAP				6,20
P40 - KÖRÜK				1,80

* Maksimum çalışma basıncı : 250 bar

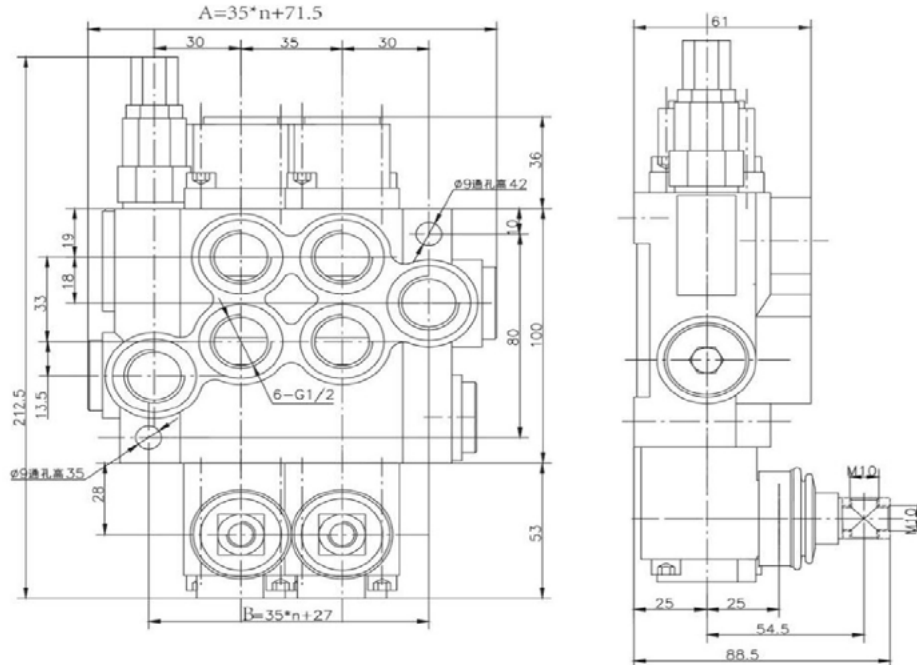



TİP	Debi	Kol Sayısı	PORT ÖLÇÜLERİ Tüm Portlar		Fiyat (USD)
			A ve B	P,T ve C	
1P80	80 lt/dak	TEKLİ	1/2"	3/4"	183,30
2P80		İKİLİ			234,30
3P80		ÜÇLÜ			285,20
4P80		DÖRTLÜ			336,00
5P80		BEŞLİ			427,70
6P80		ALTI			519,20
P80 - CARRY OVER (3/4")					11,00
P80 - DETANT KİT					31,10
P80 - KOL KAPAĞI					19,80
P80 - ARKA KAPAK					5,90
P80 - SAP					6,20
P80 - KÖRÜK					1,80

* Maksimum çalışma basıncı : 250 bar

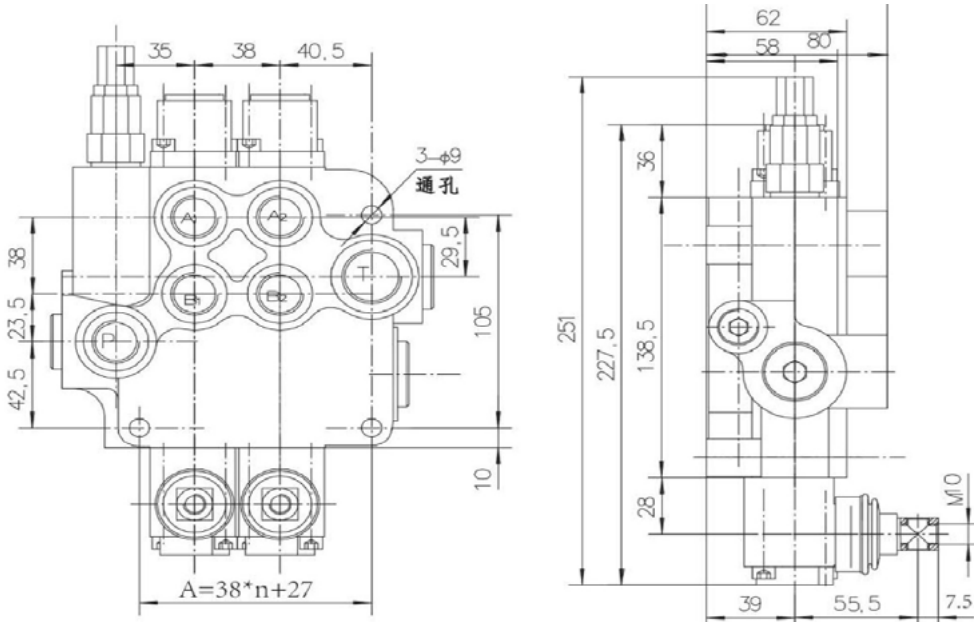

BMM Tipi Hidrolik Motorlar



Model	Mil Çapı mm	Motor Depl. (cc/rev)	Dönüş Hızı (rpm)	Δp (bar)	Tork (Nm)	Debi (lt/dak)	Fiyat (USD)
BMM8	Ø16	8,2	1950	100	11	16	174,00
BMM12.5	Ø16	12,9	1550	100	16	20	174,00
BMM20	Ø16	19,9	1000	100	25	20	174,00
BMM32	Ø16	31,6	630	100	40	20	174,00
BMM40	Ø16	39,8	500	90	45	20	174,00
BMM50	Ø16	50,3	400	70	46	20	174,00

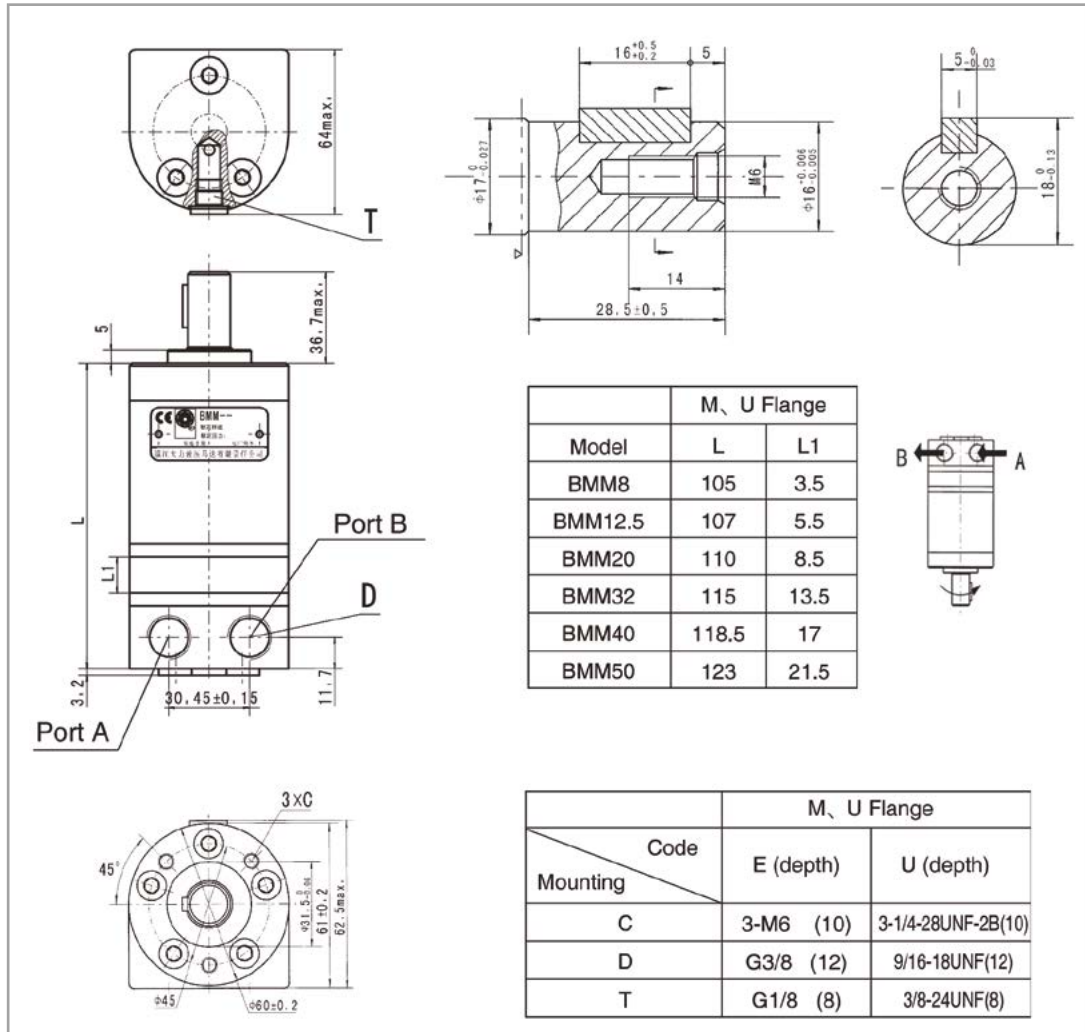

BMP Tipi Hidrolik Motorlar



Model	Mil Çapı mm	Motor Depl. (cc/rev)	Dönüş Hızı (rpm)	Δp (bar)	Tork (Nm)	Debi (lt/dak)	Fiyat (USD)
BMP36	Ø25	36	1500	125	55	55	151,00
BMP50	Ø25	51,7	1150	140	100	60	151,00
BMP80	Ø25	77,7	770	140	146	60	155,00
BMP100	Ø25	96,2	615	140	182	60	155,00
BMP125	Ø25	120,2	490	140	236	60	155,00
BMP160	Ø25	157,2	383	140	302	60	155,00
BMP200	Ø25	194,5	310	140	360	60	155,00
BMP250	Ø25	240,3	250	110	380	60	155,00
BMP315	Ø25	314,5	192	90	375	60	165,00
BMP400	Ø25	389,5	155	70	360	60	165,00

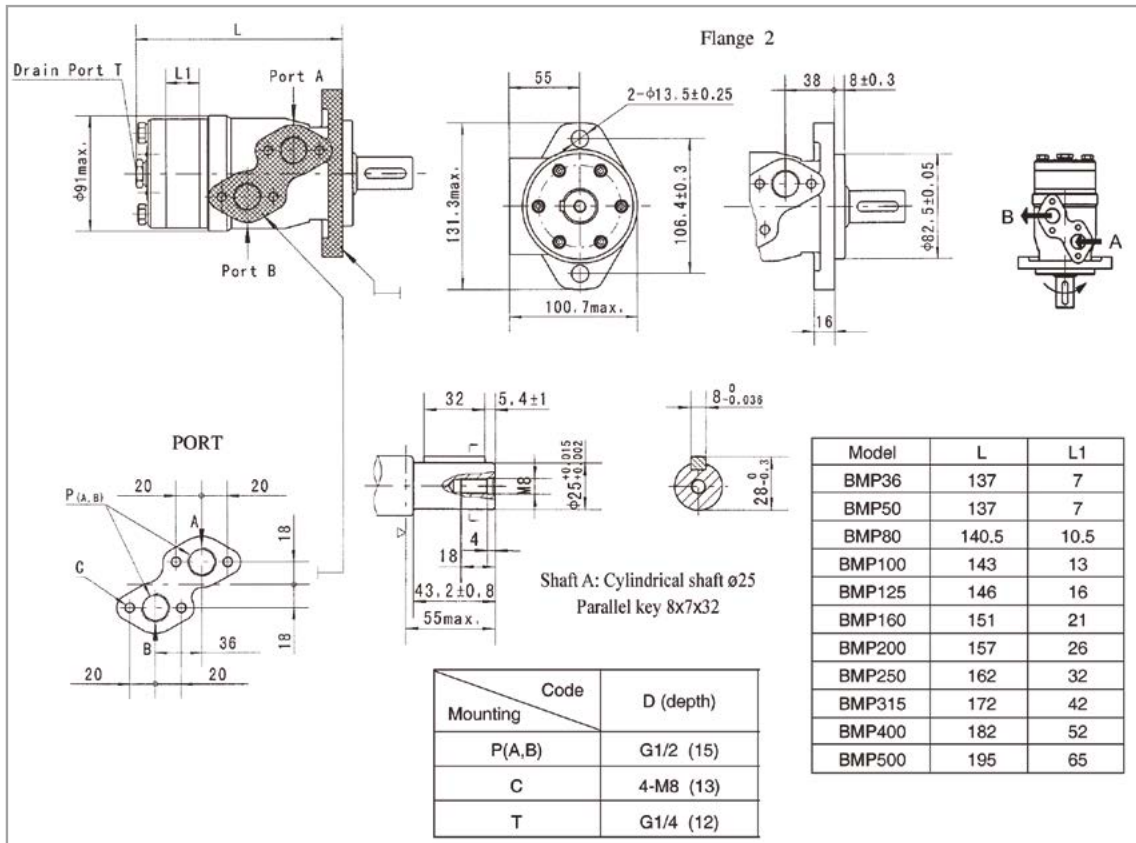

BMR Tipi Hidrolik Motorlar



Model	Mil Çapı mm	Motor Depl. (cc/rev)	Dönüş Hızı (rpm)	Δp (bar)	Tork (Nm)	Debi (lt/dak)	Fiyat (USD)
BMR36	Ø25	36	1085	140	72	40	155,00
BMR50	Ø25	51,7	960	140	100	50	155,00
BMR80	Ø25	81,5	750	175	195	60	155,00
BMR100	Ø25	102	600	175	240	60	155,00
BMR125	Ø25	127,2	475	175	300	60	155,00
BMR160	Ø25	157,2	378	165	360	60	155,00
BMR200	Ø25	194,5	310	130	360	60	155,00
BMR250	Ø25	253,3	240	110	390	60	155,00
BMR315	Ø25	317,5	190	90	390	60	165,00
BMR375	Ø25	381,4	155	70	365	60	165,00

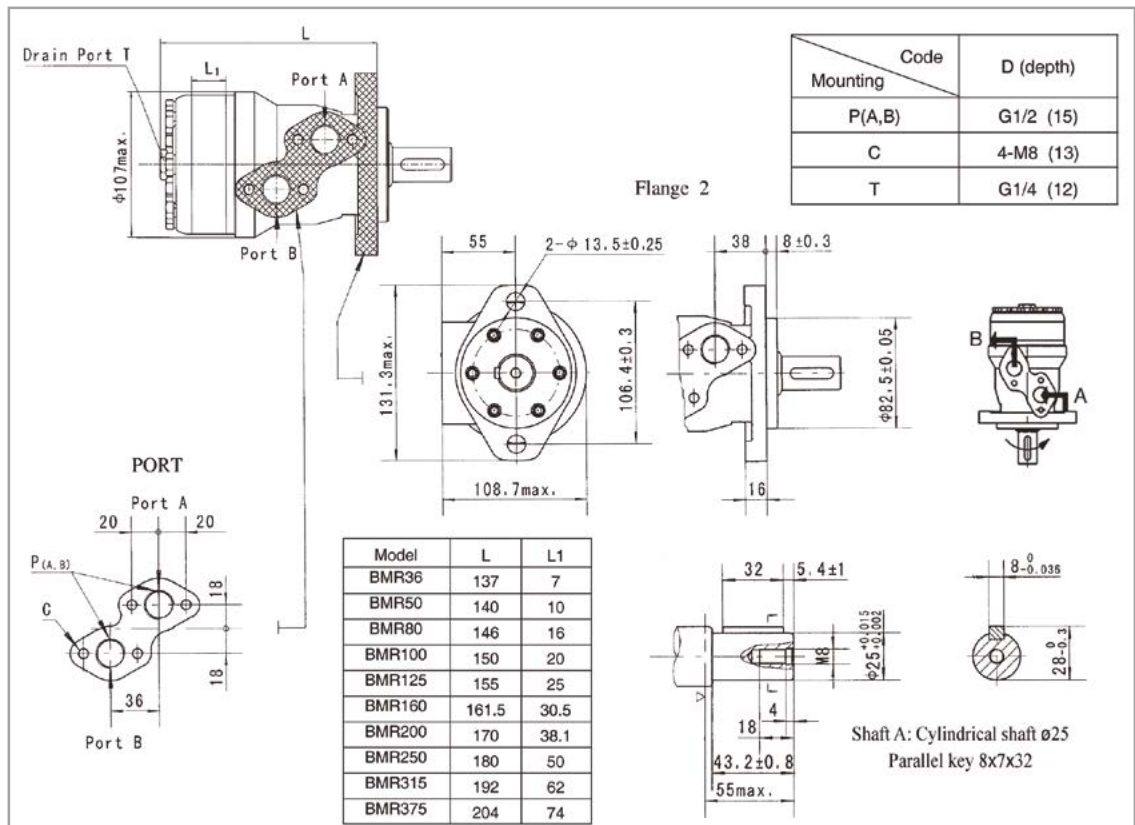

BMH Tipi Hidrolik Motorlar



Model	Mil Çapı mm	Motor Depl. (cc/rev)	Dönüş Hızı (rpm)	Δp (bar)	Tork (Nm)	Debi (lt/dak)	Fiyat (USD)
BMH400	Ø32	406,4	183	155	850	75	301,00
BMH500	Ø32	489,2	155	125	830	75	301,00
BMH400	Ø35	406,4	183	155	850	75	301,00
BMH500	Ø35	489,2	155	125	830	75	301,00

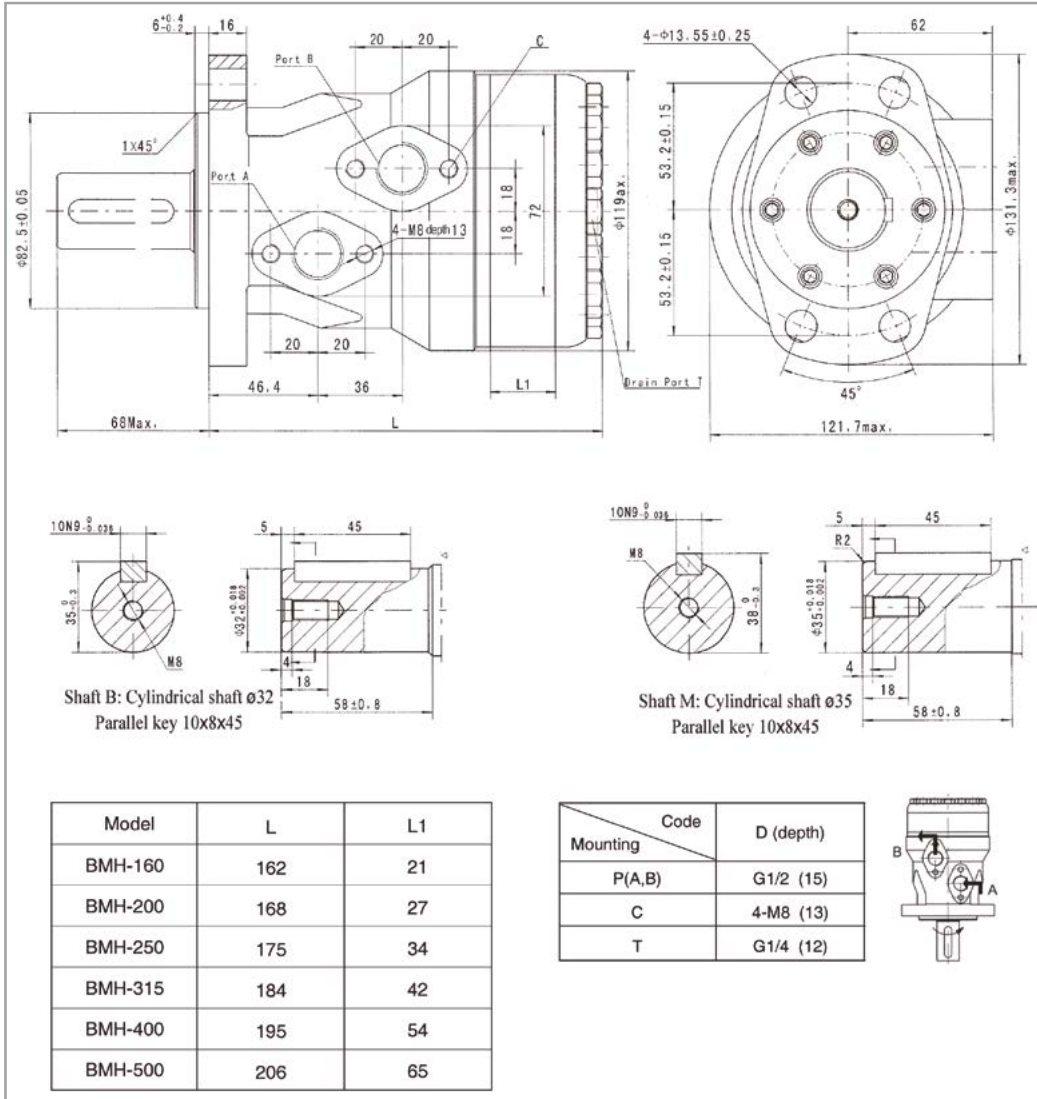

BMS Tipi Hidrolik Motorlar



Model	Mil Çapı mm	Motor Depl. (cc/rev)	Dönüş Hızı (rpm)	Δp (bar)	Tork (Nm)	Debi (lt/dak)	Fiyat (USD)
BMS80	Ø32	80,6	800	205	225	65	279,00
BMS100	Ø32	100,8	748	205	290	75	279,00
BMS125	Ø32	125	600	205	365	75	279,00
BMS160	Ø32	154	470	210	485	75	279,00
BMS200	Ø32	194	375	210	586	75	282,00
BMS250	Ø32	243	300	200	708	75	293,00
BMS315	Ø32	311	240	200	880	75	300,00
BMS400	Ø32	394	185	160	880	75	312,00

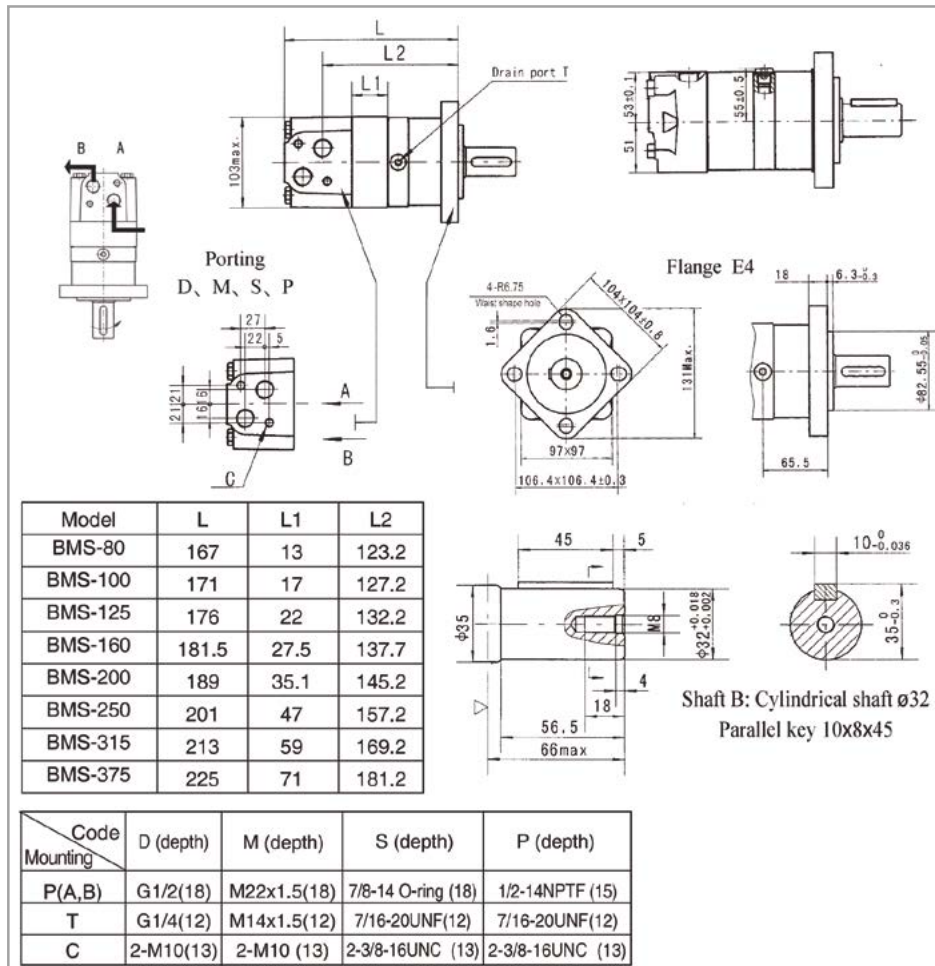

BMT Tipi Hidrolik Motorlar



Model	Mil Çapı mm	Motor Depl. (cc/rev)	Dönüş Hızı (rpm)	Δp (bar)	Tork (Nm)	Debi (lt/dak)	Fiyat (USD)
BMT160	Ø40	161,1	625	200	470	100	580,00
BMT200	Ø40	201,4	625	200	590	125	580,00
BMT250	Ø40	251,8	500	200	730	125	580,00
BMT315	Ø40	326,3	380	200	950	125	580,00
BMT400	Ø40	410,9	305	180	1080	125	580,00
BMT500	Ø40	523,6	240	160	1220	125	580,00
BMT630	Ø40	629,1	196	140	1318	125	635,00
BMT800	Ø40	801,8	154	12,5	1464	125	635,00

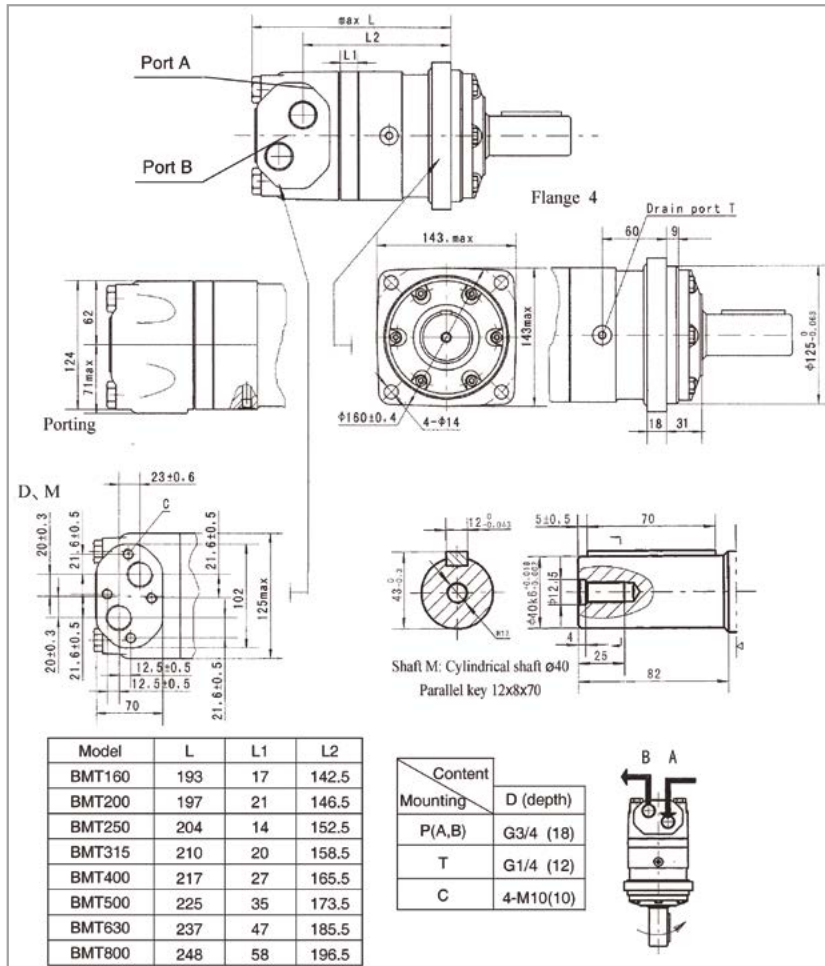

BMV Tipi Hidrolik Motorlar

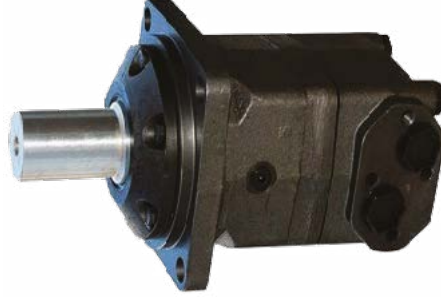

Model	Mil Çapı mm	Motor Depl. (cc/rev)	Dönüş Hızı (rpm)	Δp (bar)	Tork (Nm)	Debi (lt/dak)	Fiyat (USD)
BMV315	Ø50	333	510	200	920	160	677,00
BMV400	Ø50	419	500	200	1180	200	705,00
BMV500	Ø50	518	400	200	1460	200	748,00
BMV630	Ø50	666	320	180	1660	200	784,00
BMV800	Ø50	801	250	160	1880	200	883,00

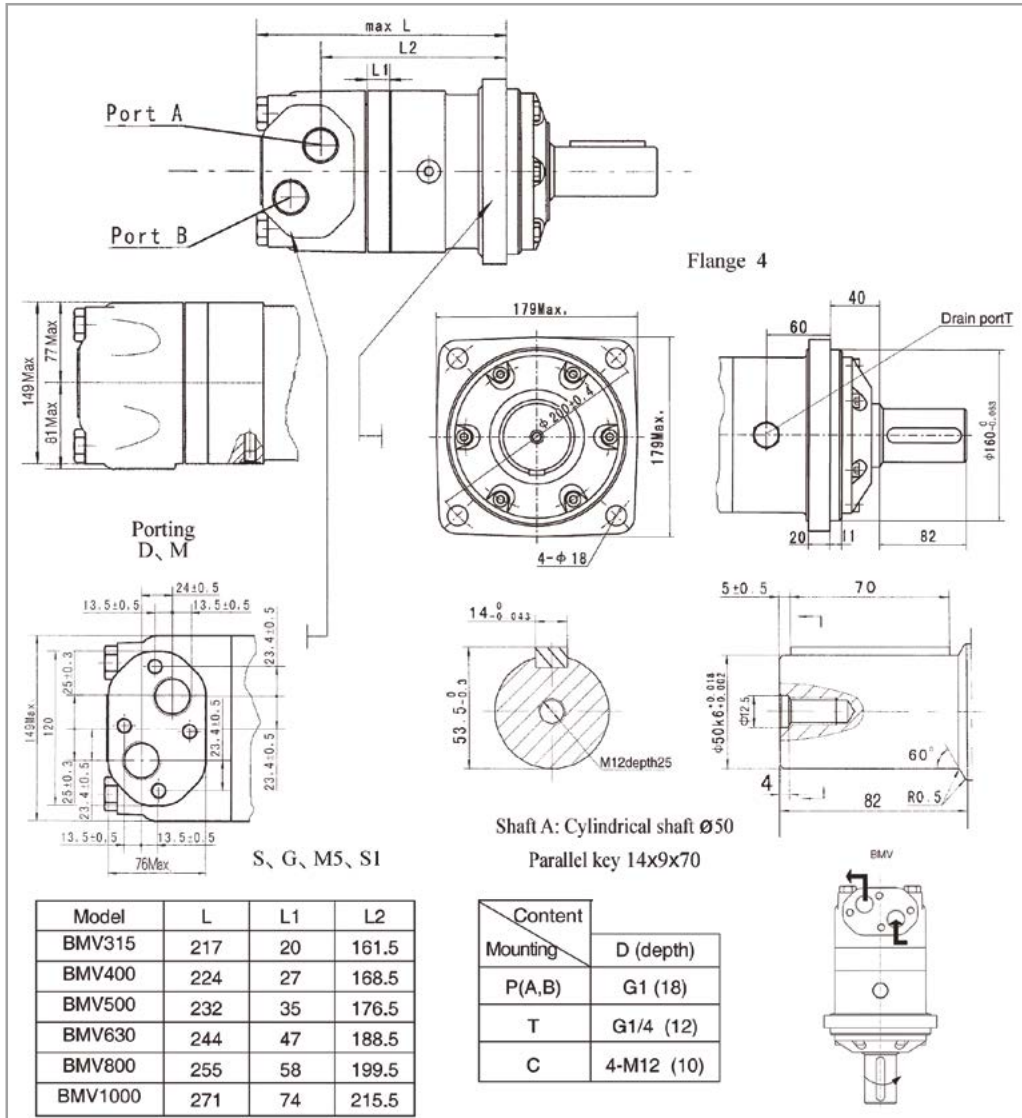



Fanlı Soğutucular



Model	Voltaj V	Soğutma Kapasitesi kcal/h	Debi lt/dak	Δp (bar)	Portlar Giriş-Çıkış	Fiyat (USD)
F2015	12 VDC	4000	80	24		312,00
	24 VDC					
	220 VAC					
	380 VAC					
F2020	12 VDC	5000	100	24	1"BSP	377,00
	24 VDC					
	220 VAC					
	380 VAC					
F2024	12 VDC	8500	120	24		515,00
	24 VDC					
	220 VAC					
	380 VAC					
F2030	12 VDC	12000	140	24		545,00
	24 VDC					
	220 VAC					
	380 VAC					
F2040	12 VDC	15000	160	24	1 1/4"BSP	660,00
	24 VDC					
	220 VAC					
	380 VAC					
F2050	12 VDC	20000	200	24		850,00
	24 VDC					
	220 VAC					
	380 VAC					

* Soğutucu fiyatlarına fan müşürü dahil değildir.

Soğutucu Fanları



Model	Voltaj V	Debi lt/dak	Fiyat (USD)
SP.FAN 2015&2020	12 VDC	225	150,00
	24 VDC		
	220 VAC	200	
	380 VAC		
SP.FAN 2024	12 VDC	280	190,00
	24 VDC		
	220 VAC	250	
	380 VAC		
SP.FAN 2030	12 VDC	305	245,00
	24 VDC		
	220 VAC	300	
	380 VAC		
SP.FAN 2040	12 VDC	385	280,00
	24 VDC		
	220 VAC	400	
	380 VAC		
SP.FAN 2050	12 VDC *	280	190,00
	24 VDC *		
	220 VAC	450	380,00
	380 VAC		

** F2050 DC soğutucular çift fanlıdır. Verilen fiyat bir adet fan içindir

Sulu Soğutucular



Model	Soğutma Kapasitesi Dt = 30° (kcal/h)	Debi lt/dak	Dp(bar)	Portlar Yağ-Su	Fiyat (USD)
OR-60	7000	60	10	3/4" - 3/4"	115,00
OR-100	12000	100	10	3/4" - 3/4"	142,00
OR-150	19000	150	10	1 1/4" - 1"	237,00
OR-250	30100	250	10	1 1/4" - 1"	320,00
OR-350	40100	350	10	1 1/4" - 1"	428,00
OR-600	62200	600	10	2" - 1 1/4"	643,00
OR-800	90150	800	10	2" - 1 1/4"	910,00



Paletli Pompa



Seri	Stok Kodu	Anma Ölçüsü Galon	Deplasman cm ³	Debi @1500 rpm lt/dak	Basınç bar	Max Hız rpm	Emiş Portu	Basınç Portu	Flanş / Şaft	Fiyat (USD)
V10 Serisi	V10-1B-1B-001C-20	1	3,3	5,0	172	4800	G 1"	G 1/2"	SAE A 19,05 mm Paralel	225,00
	V10-1B-2B-001C-20	2	6,6	9,9		4500				
	V10-1B-3B-001C-20	3	9,8	14,7		4000				
	V10-1B-4B-001C-20	4	13,1	19,7		3400				
	V10-1B-5B-001C-20	5	16,4	24,6	3200					
	V10-1B-6B-001C-20	6	19,5	29,3	152	3000				
	V10-1B-7B-001C-20	7	22,8	34,2	138	2800				

Seri	Stok Kodu	Anma Ölçüsü Galon	Deplasman cm ³	Debi @1500 rpm lt/dak	Basınç bar	Max Hız rpm	Emiş Portu	Basınç Portu	Flanş / Şaft	Fiyat (USD)
V20 Serisi	V20-1B-8B-001C-11	8	26,5	39,8	172	2800	G 1 1/4"	G 3/4"	SAE A 19,05 mm Paralel	264,00
	V20-1B-9B-001C-11	9	29,7	44,6						
	V20-1B-10B-001C-11	10	30,0	45,0						
	V20-1B-11B-001C-11	11	36,4	54,6	152	2400				
	V20-1B-12B-001C-11	12	39,0	58,5						
	V20-1B-13B-001C-11	13	42,4	63,6						

Seri	Stok Kodu	Anma Ölçüsü Galon	Deplasman cm ³	Debi @1500 rpm lt/dak	Basınç bar	Max Hız rpm	Emiş Portu	Basınç Portu	Flanş / Şaft	Fiyat (USD)
20V Serisi	20V-02A-001C-22R	2	7,5	11,3	138	1800	SAE 1 1/2"- 3000	SAE 3/4"- 3000	SAE B 22,23 mm Paralel	463,00
	20V-03A-001C-22R	3	10,0	15,0						
	20V-04A-001C-22R	4	13,0	19,5						
	20V-05A-001C-22R	5	16,5	24,8	207					
	20V-06A-001C-22R	6	19,0	28,5						
	20V-07A-001C-22R	7	23,0	34,5						
	20V-08A-001C-22R	8	27,0	40,5						
	20V-09A-001C-22R	9	30,0	45,0						
	20V-10A-001C-22R	10	32,0	48,0						
	20V-11A-001C-22R	11	36,0	54,0	159					
	20V-12A-001C-22R	12	40,0	60,0						
	20V-14A-001C-22R	14	45,0	67,5						

Paletli Pompa

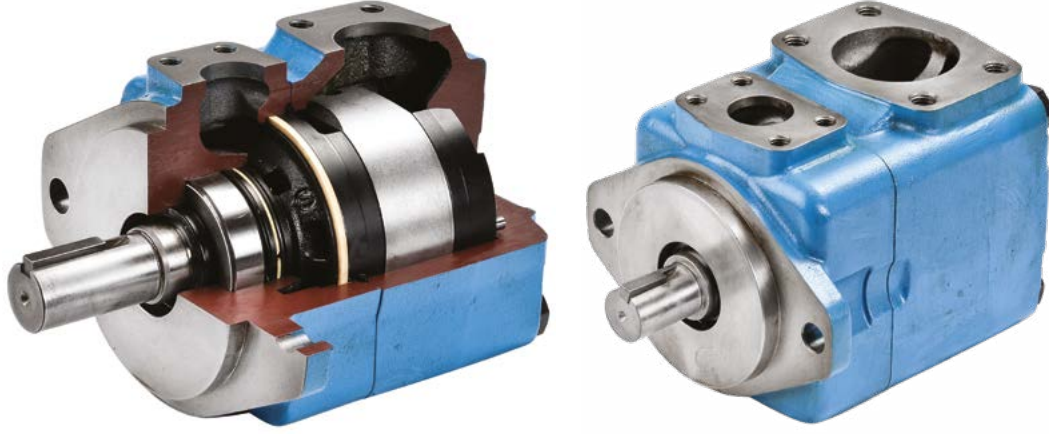

Seri	Stok Kodu	Anma Ölçüsü Galon	Deplasman cm ³	Debi @1500 rpm lt/dak	Basınç bar	Max Hız rpm	Emiş Portu	Basınç Portu	Flanş / Şaft	Fiyat (USD)
25V Serisi	25V-10A-001C-22R	10	32,5	48,8	172	1800	SAE 1 1/2"- 3000	SAE 1"-3000	SAE B 22,23 mm Paralel	516,00
	25V-12A-001C-22R	12	39,0	58,5						
	25V-14A-001C-22R	14	45,0	67,5						
	25V-17A-001C-22R	17	55,0	82,5						
	25V-19A-001C-22R	19	60,0	90,0						
	25V-21A-001C-22R	21	67,0	100,5						

Seri	Stok Kodu	Anma Ölçüsü Galon	Deplasman cm ³	Debi @1500 rpm lt/dak	Basınç bar	Max Hız rpm	Emiş Portu	Basınç Portu	Flanş / Şaft	Fiyat (USD)
35V Serisi	35V-25A-001A-22R	25	81,0	121,5	172	1800	SAE 2"-3000	SAE 1 1/4"- 3000	SAE C 31,75 mm Paralel	694,00
	35V-30A-001A-22R	30	97,0	145,5						
	35V-35A-001A-22R	35	112,0	168,0						
	35V-38A-001A-22R	38	121,0	181,5						
	35V-45A-001A-22R	45	147,0	220,5	138					

Seri	Stok Kodu	Anma Ölçüsü Galon	Deplasman cm ³	Debi @1500 rpm lt/dak	Basınç bar	Max Hız rpm	Emiş Portu	Basınç Portu	Flanş / Şaft	Fiyat (USD)
45V Serisi	45V-42A-086A-22R	42	138,0	207,0	172	1800	SAE 2"-3000	SAE 1 1/4"- 3000	SAE C 31,75 mm Paralel	859,00
	45V-45A-086A-22R	45	147,0	220,5						
	45V-50A-086A-22R	50	162,0	243,0						
	45V-57A-086A-22R	57	181,0	271,5						
	45V-60A-086A-22R	60	193,0	289,5						
	45V-66A-086A-22R	66	212,0	318,0						
	45V-75A-086A-22R	75	237,0	355,5	138					

Paletli Pompa Kartuş (Cartridge Kit)



Seri	Stok Kodu	Anma Ölçüsü Galon	Fiyat (USD)	
V10 Serisi	PCV1001R	1	155,00	
	PCV1002R	2	155,00	
	PCV1003R	3	155,00	
	PCV1004R	4	155,00	
	PCV1005R	5	155,00	
	PCV1006R	6	155,00	
	PCV1007R	7	155,00	
V20 Serisi	PCV2008R	8	171,00	
	PCV2009R	9	171,00	
	PCV2010R	10	171,00	
	PCV2011R	11	171,00	
	PCV2012R	12	171,00	
	PCV2013R	13	171,00	
20V Serisi	PC20V02R	2	244,00	
	PC20V03R	3	244,00	
	PC20V04R	4	244,00	
	PC20V05R	5	244,00	
	PC20V06R	6	244,00	
	PC20V07R	7	244,00	
	PC20V08R	8	244,00	
	PC20V09R	9	244,00	
	PC20V10R	10	244,00	
	PC20V11R	11	244,00	
	PC20V12R	12	244,00	
	PC20V14R	14	244,00	
	25V Serisi	PC25V10R	10	290,00
		PC25V12R	12	290,00
PC25V14R		14	290,00	
PC25V17R		17	290,00	
PC25V19R		19	290,00	
PC25V21R		21	290,00	
35V Serisi	PC35V25R	25	362,00	
	PC35V30R	30	362,00	
	PC35V35R	35	362,00	
	PC35V38R	38	362,00	
	PC35V45R	45	362,00	
45V Serisi	PC45V42R	42	440,00	
	PC45V45R	45	440,00	
	PC45V50R	50	440,00	
	PC45V57R	57	440,00	
	PC45V60R	60	440,00	
	PC45V66R	66	440,00	
	PC45V75R	75	440,00	

Dişli Pompalar



Grubu	Stok Kodu	Dönüş Yönü	Deplasman	Debi @1500 rpm	Flanş Tipi	Şaft Tipi	İşletme Basıncı	Max Hız	Flanş / Şaft	Fiyat (USD)	
0P1 - Grup 1	BAP1B2 S 1.4 C12F3	SOL	1,4 cc	2,1 lt/dak 1,8	B Tipi	Paralel	250 bar	6000 rpm	B Tipi, Paralel	77,00	
	BAP1B2 D 1.4 C12F3	SAĞ						4000 rpm			
	BAP1B2 S 2.8 C12F3	SOL	2,8 cc	4,2 lt/dak				4000 rpm			
1PN - Grup 2	BHP2HB0D4.5 T0E0	SAĞ	4.5 cc	6,8 lt/dak	B Tipi	1/8 Konik	270 bar	3500 rpm	B Tipi, Paralel	119,50	
	BHP2HB0D6.3 T0E0	SAĞ	6.3 cc	9,5 lt/dak							
	BHP2HB0D8.2 T0E0	SAĞ	8.2 cc	12,3 lt/dak							
	BHP2HB0D10 T0E0	SAĞ	10 cc	15 lt/dak							
	BHP2HB0D12 T0E1	SAĞ	12 cc	18 lt/dak							
	BHP2HB0D14 T0E1	SAĞ	14 cc	21 lt/dak							
	BHP2HB0D16 T0E1	SAĞ	16 cc	24 lt/dak							
	BHP2HB0D19 T0E1	SAĞ	19 cc	28,5 lt/dak							
	BHP2HB0D22 T0E1	SAĞ	22 cc	33 lt/dak							
	BHP2HB0D28 T0E0	SAĞ	28 cc	42 lt/dak							
2P1 - Grup 3	BHP3B1S33 T2 E5	SOL	33 cc	49,5 lt/dak	B Tipi	1/8 Konik	230 bar	3000 rpm	B Tipi, Paralel	235,00	
	BHP3B1S39 C2 E8	SOL									
	BHP3B1S39 T2 E5	SOL	39 cc	58,5 lt/dak		1/8 Konik					
	BHP3B1D39 T2 E5	SAĞ									
	BHP3B1S50 C2 E8	SOL	50 cc	75 lt/dak		Paralel			220 bar		B Tipi, Paralel
	BHP3B1S50 T2 E5	SOL									
	BHP3B1S55 C2 E8	SOL	55 cc	82,5 lt/dak		Paralel			200 bar		2800 rpm
3P1 - Grup 3.5	BAP3.5B0S63C4F2	SOL	63 cc	94,5 lt/dak	B Tipi	Paralel	250 bar	2750 rpm	B Tipi, Paralel	445,00	
	BAP3.5B0D63C4F2	SAĞ									
	BAP3.5B0S80C4F2	SOL	80 cc	120 lt/dak			230 bar	2500 rpm			
	BAP3.5B0D80C4F2	SAĞ									
	BAP3.5B0S90C4F2	SOL	90 cc	135 lt/dak			200 bar				
	BAP3.5B0D90C4F2	SAĞ									



NG6 Tek Bobin Elektrik Uyarılı Yön Denetim Valfleri

Fotograf	Stok Kodu	Model	Fiyat (USD)
	SWH-G02-C3BS-A220-20	NG6 TEK BOBİN 4/2 TB HM - A220	89,90
	SWH-G02-C3BS-A110-20	NG6 TEK BOBİN 4/2 TB HM - A110	89,90
	SWH-G02-C3BS-D12-20	NG6 TEK BOBİN 4/2 TB HM - D12	89,90
	SWH-G02-C3BS-D24-20	NG6 TEK BOBİN 4/2 TB HM - D24	89,90
Fotograf	Stok Kodu	Model	Fiyat (USD)
	SWH-G02-B3-A110-20	NG6 TEK BOBİN 4/2 HA - A110	89,90
	SWH-G02-B3-D24-20	NG6 TEK BOBİN 4/2 HA - D24	89,90
	SWH-G02-B3-A220-20	NG6 TEK BOBİN 4/2 HA - A220	89,90
Fotograf	Stok Kodu	Model	Fiyat (USD)
	SWH-G02-C3B-A110-20	NG6 TEK BOBİN 4/2 HM TB - A110	89,90
Fotograf	Stok Kodu	Model	Fiyat (USD)
	SWH-G02-C2BS-D12-20	NG6 TEK BOBİN 4/2 TB KM - D12	89,90
	SWH-G02-C2BS-A220-20	NG6 TEK BOBİN 4/2 TB KM - A220	89,90
	SWH-G02-C2BS-A110-20	NG6 TEK BOBİN 4/2 TB KM - A110	89,90



NG6 Çift Bobin Elektrik Uyarılı Yön Denetim Valfleri

Fotoğraf	Stok Kodu	Model	Fiyat (USD)
	SWH-G02-C3-D12-20	NG6 ÇİFT BOBİN 4/3 HM - D12	124,90
	SWH-G02-C3-D24-20	NG6 ÇİFT BOBİN 4/3 HM - D24	124,90
	SWH-G02-C3-A110-20	NG6 ÇİFT BOBİN 4/3 HM – A110	124,90
	SWH-G02-C3-A220-20	NG6 ÇİFT BOBİN 4/3 HM – A220	124,90
	SWH-G02-C6-A110-20	NG6 ÇİFT BOBİN 4/3 AM - A110	124,90
	SWH-G02-D2-D12-20	NG6 ÇİFT BOBİN 4/2 DETANTLI – D12	124,90
	SWH-G02-D2-D24-20	NG6 ÇİFT BOBİN 4/2 DETANTLI – D24	124,90

Max Çalışma Basıncı : 315 bar
Max Debi : 63 lt/dak
Çalışma Sıcaklığı : -25 ~ 90 °C



NG10 Tek Bobin Elektrik Uyarılı Yön Denetim Valfleri

Fotograf	Stok Kodu	Model	Fiyat (USD)
	SWH-G03-B2-A220-20	NG10 TEK BOBİN 4/2 TB - A220	144,90
	SWH-G03-B2-D12-20	NG10 TEK BOBİN 4/2 TB - D12	144,90
	SWH-G03-B2-A110-20	NG10 TEK BOBİN 4/2 TB - A110	144,90
	SWH-G03-B2-D24-20	NG10 TEK BOBİN 4/2 TB - D24	144,90

* Kapalı Geçişli

Fotograf	Stok Kodu	Model	Fiyat (USD)
	SWH-G03-B3-D12-20	NG10 TEK BOBİN 4/2 HA - D12	144,90
	SWH-G03-B3-D24-20	NG10 TEK BOBİN 4/2 HA - D24	144,90
	SWH-G03-B3-A110-20	NG10 TEK BOBİN 4/2 HA - A110	144,90
	SWH-G03-B3-A220-20	NG10 TEK BOBİN 4/2 HA - A220	144,90

* Kapalı Geçişli

Fotograf	Stok Kodu	Model	Fiyat (USD)
	SWH-G03-C2BS-A110-20	NG10 TEK BOBİN 4/2 TB KM - A110	144,90
	SWH-G03-C2BS-D12-20	NG10 TEK BOBİN 4/2 TB KM - D12	144,90
	SWH-G03-C2BS-D24-20	NG10 TEK BOBİN 4/2 TB KM - D24	144,90
	SWH-G03-C2BS-A220-20	NG10 TEK BOBİN 4/2 TB KM - A220	144,90

Fotograf	Stok Kodu	Model	Fiyat (USD)
	SWH-G03-C3BS-D12-20	NG10 TEK BOBİN 4/2 TB HM - D12	144,90
	SWH-G03-C3BS-D24-20	NG10 TEK BOBİN 4/2 TB HM - D24	144,90
	SWH-G03-C3BS-A110-20	NG10 TEK BOBİN 4/2 TB HM - A110	144,90



NG10 Tek Bobin Elektrik Uyarılı Yön Denetim Valfleri

Fotograf	Stok Kodu	Model	Fiyat (USD)
	SWH-G03-C3B-D12-20	NG10 TEK BOBİN 4/2 HM TB – D12	144,90
	SWH-G03-C3B-D24-20	NG10 TEK BOBİN 4/2 HM TB – D24	144,90
	SWH-G03-C3B-A220-20	NG10 TEK BOBİN 4/2 HM TB – A220	144,90

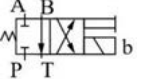
Fotograf	Stok Kodu	Model	Fiyat (USD)
	SWH-G03-C8SB-D24-20	NG10 TEK BOBİN 4/2 TB BT – D24	144,90
	SWH-G03-C8SB-A220-20	NG10 TEK BOBİN 4/2 TB BT – A220	144,90

Fotograf	Stok Kodu	Model	Fiyat (USD)
	SWH-G03-C7B-D24-20	NG10 TEK BOBİN 4/2 TB ABP – D24	144,90

Fotograf	Stok Kodu	Model	Fiyat (USD)
	SWH-G03-C5B-D24-20	NG10 TEK BOBİN 4/2 TB PTA – D24	144,90
	SWH-G03-C5B-A220-20	NG10 TEK BOBİN 4/2 TB PTA – A220	144,90

Max Çalışma Basıncı : 315 bar
Max Debi : 120 lt/dak
Çalışma Sıcaklığı : -25 ~ 90 °C



NG10 Çift Bobin Elektrik Uyarılı Yön Denetim Valfleri

Fotograf	Stok Kodu	Model	Fiyat (USD)
	SWH-G03-C2-A110-20	NG10 ÇİFT BOBİN 4/3 KM - A110	184,90
	SWH-G03-C2-A220-20	NG10 ÇİFT BOBİN 4/3 KM - A220	184,90
	SWH-G03-C2-D12-20	NG10 ÇİFT BOBİN 4/3 KM - D12	184,90

Fotograf	Stok Kodu	Model	Fiyat (USD)
	SWH-G03-C3-D12-20	NG10 ÇİFT BOBİN 4/3 HM – D12	184,90
	SWH-G03-C3-D24-20	NG10 ÇİFT BOBİN 4/3 HM – D24	184,90
	SWH-G03-C3-A110-20	NG10 ÇİFT BOBİN 4/3 HM – A110	184,90
	SWH-G03-C3-A220-20	NG10 ÇİFT BOBİN 4/3 HM – A220	184,90

Fotograf	Stok Kodu	Model	Fiyat (USD)
	SWH-G03-C4-A110-20	NG10 ÇİFT BOBİN 4/3 ABT - A110	184,90
	SWH-G03-C4-A220-20	NG10 ÇİFT BOBİN 4/3 ABT - A220	184,90
	SWH-G03-C4-D12-20	NG10 ÇİFT BOBİN 4/3 ABT - D12	184,90
	SWH-G03-C4-D24-20	NG10 ÇİFT BOBİN 4/3 ABT - D24	184,90

Fotograf	Stok Kodu	Model	Fiyat (USD)
	SWH-G03-C6-A110-20	NG10 ÇİFT BOBİN 4/3 AM - A110	184,90
	SWH-G03-C6-A220-20	NG10 ÇİFT BOBİN 4/3 AM - A220	184,90
	SWH-G03-C6-D12-20	NG10 ÇİFT BOBİN 4/3 AM - D12	184,90
	SWH-G03-C6-D24-20	NG10 ÇİFT BOBİN 4/3 AM - D24	184,90

Fotograf	Stok Kodu	Model	Fiyat (USD)
	SWH-G03-C8S-D24-20	NG10 ÇİFT BOBİN 4/3 BT – D24	184,90
	SWH-G03-C8S-A220-20	NG10 ÇİFT BOBİN 4/3 BT – A220	184,90

Fotograf	Stok Kodu	Model	Fiyat (USD)
	SWH-G03-C7-D24-20	NG10 ÇİFT BOBİN 4/3 ABP – D24	184,90
	SWH-G03-C7-A220-20	NG10 ÇİFT BOBİN 4/3 ABP – A220	184,90

Fotograf	Stok Kodu	Model	Fiyat (USD)
	SWH-G03-C5-A220-20	NG10 ÇİFT BOBİN 4/3 PTA -A220	184,90

NG16, NG25 ve NG32 Elektrik Uyarılı Yön Denetim Valfleri (GÖVDE)

HPD-G06-C



HPD-G10-C

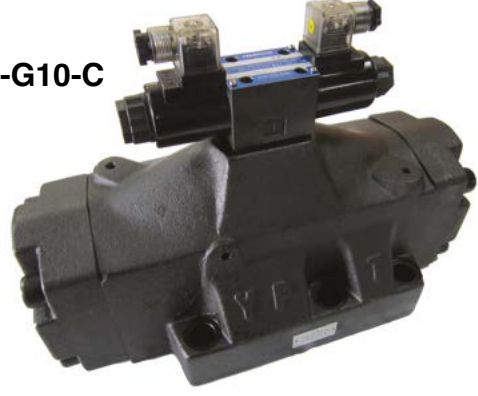







Fotograf	Stok Kodu	Model	Fiyat (USD)
	HPD-G04-B2-ET	NG16 4/2 GÖVDE	178,90
	HPD-G06-B2-ET	NG25 4/2 GÖVDE	289,90
	HPD-G10-B2-ET	NG32 4/2 GÖVDE	1.479,90
	HPD-G10-C2-ET	NG32 4/3 GÖVDE - KAPALI MERKEZ	1.479,90
	HPD-G04-C3-ET	NG16 4/3 GÖVDE - H MERKEZ	178,90
	HPD-G06-C3-ET	NG25 4/3 GÖVDE - H MERKEZ	289,90
	HPD-G10-C3-ET	NG32 4/3 GÖVDE - H MERKEZ	1.479,90
	HPD-G10-C4-ET	NG32 4/3 GÖVDE - ABT	1.479,90
	HPD-G04-C6-ET	NG16 4/3 GÖVDE - AÇIK MERKEZ	184,90
	HPD-G10-C6-ET	NG32 4/3 GÖVDE - AÇIK MERKEZ	1.479,90

* Pilot valfi fiyata dahil değildir, haricen sipariş verilmelidir

** Valfler; harici pilot ve harici sızıntılıdır

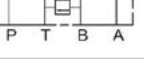
Modüler Basınç Emniyet Valfleri



Fotograf	Stok Kodu	Model	Fiyat (USD)
 MRF-P	MRF-02P-3-40-K(B)	BASINÇ AYAR VALFİ NG6 P HATTI, 70~210 bar	139,90
 MRF-A	MRF-02A-3-40-K(B)	BASINÇ AYAR VALFİ NG6 A HATTI, 70~210 bar	139,90
 MRF-B	MRF-02B-3-40-K(B)	BASINÇ AYAR VALFİ NG6 B HATTI, 70~210 bar	139,90
 MRF-B	MRF-03P-3-30-K(B)	BASINÇ AYAR VALFİ NG10 P HATTI, 70~210 bar	174,90
 MRF-B	MRF-03A-3-30-K(B)	BASINÇ AYAR VALFİ NG10 A HATTI, 70~210 bar	174,90
 MRF-C	MRF-03B-3-30-K(B)	BASINÇ AYAR VALFİ NG10 B HATTI, 70~210 bar	174,90
 MRF-C	MRF-03C-3-30-K	BASINÇ AYAR VALFİ NG10 AB HATTI, 70~210 bar	239,90

Modüler Pilot Kumandalı Çekvalf (Kilit Valfi)

MPC-02W-40



MPC-03W-40



MPC-04W-40





MPC-06W-40



Fotograf	Stok Kodu	Model	Fiyat (USD)
MPC-A 	MPC-02A-40	KİLİT VALF NG6 A HATTI	69,90
MPC-B 	MPC-02B-40	KİLİT VALF NG6 B HATTI	69,90
MPC-B 	MPC-03A-40	KİLİT VALF NG10 A HATTI	94,90
MPC-B 	MPC-03B-40	KİLİT VALF NG10 B HATTI	94,90
MPC-W 	MPC-03W-40	KİLİT VALF NG10 AB HATTI	109,90
MPC-W 	MPC-04W-40	KİLİT VALF NG16 AB HATTI	NET FİYAT 170,07
MPC-W 	MPC-06W-40	KİLİT VALF NG25 AB HATTI	NET FİYAT 178,17

Modüler Basınç Düşürücü Valfler

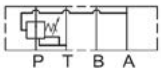
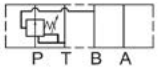

Fotograf	Stok Kodu	Model	Fiyat (USD)
<p>MPR-A</p> 	MPR-03A-3-30-K(B)	BASINÇ DÜŞÜRÜCÜ VALF NG10 A HATTI, 70~210 bar	102,90
<p>MPR-B</p> 	MPR-03B-3-30-K(B)	BASINÇ DÜŞÜRÜCÜ VALF NG10 B HATTI, 70~210 bar	102,90
<p>MPR-P</p> 	MPR-03P-3-30-K(B)	BASINÇ DÜŞÜRÜCÜ VALF NG10 P HATTI, 70~210 bar	102,90

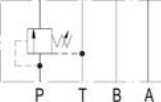

Modüler Basınç Sıralama Valfi (NG6)

Fotograf	Stok Kodu	Model	Fiyat (USD)
<p>MSV</p> 	MSV-02P-2-K	BASINÇ SIRALAMA VALFİ NG6 P HATTI, 7~210 bar	144,90

Modüler Basınç Şalterleri (Ng 6)

MPS-02W-230-20-K

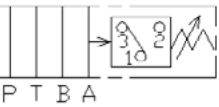
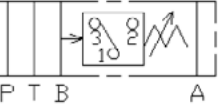
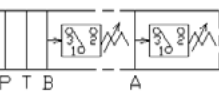

Fotograf	Stok Kodu	Model	Fiyat (USD)
	MPS-02P-150-20-K-B	MODULER BASINÇ ŞALTERİ P HATTI 30~150 bar	139,90
	MPS-02P-230-20-K-B	MODULER BASINÇ ŞALTERİ P HATTI 50~230 bar	139,90
	MPS-02A-150-20-K-A	MODULER BASINÇ ŞALTERİ A HATTI 30~150 bar	139,90
	MPS-02A-230-20-K-A	MODULER BASINÇ ŞALTERİ A HATTI 50~230 bar	139,90
	MPS-02B-150-20-K-A	MODULER BASINÇ ŞALTERİ B HATTI 30~150 bar	139,90
	MPS-02B-230-20-K-A	MODULER BASINÇ ŞALTERİ B HATTI 50~230 bar	139,90
	MPS-02W-150-20-K	MODULER BASINÇ ŞALTERİ AB HATTI 30~150 bar	294,90
	MPS-02W-230-20-K	MODULER BASINÇ ŞALTERİ AB HATTI 50~230 bar	329,90

Modüler Hız Ayar Valfleri

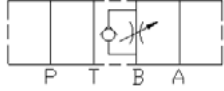

Fotograf	Stok Kodu	Model	Fiyat (USD)
	MT-02A-30-K	DEBİ AYAR VALF NG6 A HATTI	69,90
	MT-03A-30-K	DEBİ AYAR VALF NG10 A HATTI	94,90
	MT-02B-30-K	DEBİ AYAR VALF NG6 B HATTI	69,90
	MT-03B-30-K	DEBİ AYAR VALF NG10 B HATTI	94,90

Pleyt Tipi Emniyet Valfler

HRF-G03-3-R-30



HSRF-G06-1PN-3-R-A220-20

Fotograf	Stok Kodu	Model	Fiyat (USD)
	HRF-G03-3-R-30	BASINÇ AYAR NG10 MANUEL	244,90
	HRF-G06-3-R-30	BASINÇ AYAR NG25 MANUEL	269,90
	HSRF-G03-1PN-3-R-30 W/O	SIFIRLAMALI TİP BASINÇ AYAR NG10 - GÖVDE *	259,90
	HSRF-G06-1PN-3-R-30 W/O	SIFIRLAMALI TİP BASINÇ AYAR NG25 - GÖVDE *	279,90

Not: Ayar basınç aralığı 7 ~ 210 bar'dır

* Pilot valf hariçtir

** Pilot valfi fiyata dahil olup montajlı olarak teslim edilir.

Basınç Şalterleri



DNL-100K-21B



Fotograf	Stok Kodu	Model	Fiyat (USD)
	PS-150-20	1/4" HAT TİPİ BASINÇ ŞALTERİ 30~150 bar	139,90
	DNL-100K-21B	BASINÇ ŞALTERİ - DNL 100K 15~100 bar	204,90
	DNL-400K-21B	BASINÇ ŞALTERİ - DNL 400K 50~400 bar	204,90

Valf Blokları



Stok Kodu	Açıklama	Fiyat (USD)
M02-03-2S2B	NG6 VALF BLOĞU TEKLİ Alt/Yan Çıkış	32,20
M02-3E-1	NG6 VALF BLOĞU YANDAN ÇIKIŞ 3'LÜ	98,90
M03-04-4B	NG10 VALF BLOĞU TEKLİ Alttan Çıkış	46,00
M03-04-4S	NG10 VALF BLOĞU TEKLİ Yandan Çıkış	64,70
M03-04-3S1B	NG10 VALF BLOĞU TEKLİ P, A, B Yandan - T Altan Çıkışlı	60,00
M03-1E-1	NG10 VALF BLOĞU YANDAN ÇIKIŞ TEKLİ	60,00
M03-2E-1	NG10 VALF BLOĞU YANDAN ÇIKIŞ 2'Lİ	166,00
M03-4E-1	NG10 VALF BLOĞU YANDAN ÇIKIŞ 4'LÜ	332,00
M03-5E-1	NG10 VALF BLOĞU YANDAN ÇIKIŞ 5'Lİ	395,70
M03-6E-1	NG10 VALF BLOĞU YANDAN ÇIKIŞ 6'Lİ	492,20
M03-7E-1	NG10 VALF BLOĞU YANDAN ÇIKIŞ 7'Lİ	573,70
M03-8E-1	NG10 VALF BLOĞU YANDAN ÇIKIŞ 8'Lİ	656,30
M03-9E-1	NG10 VALF BLOĞU YANDAN ÇIKIŞ 9'LU	738,30
M03-10E-1	NG10 VALF BLOĞU YANDAN ÇIKIŞ 10'LU	676,30

Valf Aksesuarları

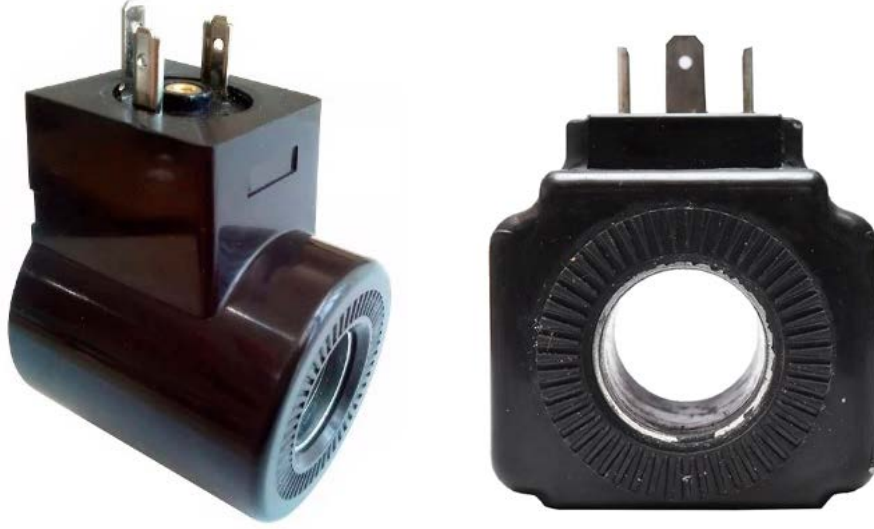

Stok Kodu	Ölçü (İç Çap x Boy)	Açıklama	Fiyat (USD)
COIL-G02-D12-20	Ø20 x 52,8 mm	BOBIN NG6 12 VOLT DC	27,90
COIL-G02-D24-20	Ø20 x 52,8 mm	BOBIN NG6 24 VOLT DC	27,90
COIL-G02-A110-20	Ø20 x 52,8 mm	BOBIN NG6 110 VOLT AC	27,90
COIL-G02-A220-20	Ø20 x 52,8 mm	BOBIN NG6 220 VOLT AC	27,90
COIL-G03-D12-20	Ø26,2 x 74 mm	BOBIN NG10 12 VOLT DC	57,90
COIL-G03-D24-20	Ø26,2 x 74 mm	BOBIN NG10 24 VOLT DC	57,90
COIL-G03-A110-20	Ø26,2 x 46,9 mm	BOBIN NG10 110 VOLT AC	57,90
COIL-G03-A220-20	Ø26,2 x 46,9 mm	BOBIN NG10 220 VOLT AC	57,90

R1-R2 SOKETİ - FIRETECH



Stok Kodu	Ölçü	Koli Adedi	Fiyat (USD)
00210-03	3/16"	750	0,33
00210-04	1/4"	500	0,37
00210-05	5/16"	440	0,39
00210-06	3/8"	400	0,45
00210-08	1/2"	300	0,59
00210-10	5/8"	200	0,97
00210-12	3/4"	150	1,27
00210-16	1"	90	1,92
00210-20	1 1/4"	48	2,92
00210-24	1 1/2"	25	4,41
00210-32	2"	18	5,79

METRİK SOMUNLU DÜZ HORTUM RAKORU - L TİPİ



Stok Kodu	Ölçü	Koli Adedi	Fiyat (USD)
20411-14-04	1/4" - M14X1,5 8L	425	0,68
20411-16-04	1/4" - M16X1,5 10L	400	0,82
20411-18-04	1/4" - M18X1,5 12L	400	1,07
20411-16-05	5/16" - M16X1,5 10L	400	0,82
20411-18-05	5/16" - M18X1,5 12L	400	0,92
20411-16-06	3/8" - M16X1,5 10L	400	1,04
20411-18-06	3/8" - M18X1,5 12L	250	0,88
20411-22-06	3/8" - M22X1,5 15L	200	1,42
20411-18-08	1/2" - M18X1,5 12L	250	1,50
20411-22-08	1/2" - M22X1,5 15L	200	1,16
20411-26-08	1/2" - M26X1,5 18L	150	1,84
20411-26-10	5/8" - M26X1,5 18L	125	1,84
20411-30-12	3/4" - M30X2 22L	75	2,77

METRİK SOMUNLU 90° HORTUM RAKORU - L TİPİ



Stok Kodu	Ölçü	Koli Adedi	Fiyat (USD)
20491-14-04	1/4" - M14X1,5 8L	300	1,16
20491-16-04	1/4" - M16X1,5 10L	300	1,29
20491-18-04	1/4" - M18X1,5 12L	250	1,58
20491-16-05	5/16" - M16X1,5 10L	300	1,09
20491-18-05	5/16" - M18X1,5 12L	250	1,36
20491-16-06	3/8" - M16X1,5 10L	300	1,58
20491-18-06	3/8" - M18X1,5 12L	250	1,42
20491-22-06	3/8" - M22X1,5 15L	125	1,98
20491-18-08	1/2" - M18X1,5 12L	200	1,98
20491-22-08	1/2" - M22X1,5 15L	100	1,84
20491-26-08	1/2" - M26X1,5 18L	75	3,54
20491-26-10	5/8" - M26X1,5 18L	50	3,56
20491-30-12	3/4" - M30X2 22L	40	4,29

METRİK SOMUNLU DÜZ HORTUM RAKORU - S TİPİ



Stok Kodu	Ölçü	Koli Adedi	Fiyat (USD)
20511-20-06	3/8" - M20X1,5 12S	250	1,01
20511-24-08	1/2" - M24X1,5 16S	150	1,72
20511-30-10	5/8" - M30X2 20S	100	3,06
20511-30-12	3/4" - M30X2 20S	75	2,69
20511-36-12	3/4" - M36X2 25S	75	4,47
20511-36-16	1" - M36X2 25S	75	4,37
20511-42-16	1" - M42X2 30S	50	6,69
20511-52-20	1 1/4" - M52X2 38S	30	10,08
20511-52-24	1 1/2" - M52X2 38S	30	9,96

METRİK SOMUNLU 90° HORTUM RAKORU - S TİPİ



Stok Kodu	Ölçü	Koli Adedi	Fiyat (USD)
20591-20-06	3/8" - M20X1,5 12S	150	1,72
20591-24-08	1/2" - M24X1,5 16S	125	2,33
20591-30-10	5/8" - M30X2 20S	75	4,29
20591-30-12	3/4" - M30X2 20S	50	4,29
20591-36-12	3/4" - M36X2 25S	50	5,51
20591-36-16	1" - M36X2 25S	50	6,74
20591-42-16	1" - M42X2 30S	25	8,58
20591-52-20	1 1/4" - M52X2 38S	15	15,32
20591-52-24	1 1/2" - M52X2 38S	15	17,79

UNF SOMUNLU DÜZ HORTUM RAKORU



Stok Kodu	Ölçü	Koli Adedi	Fiyat (USD)
26711-06-04	1/4" - 9/16"	500	0,78
26711-06-06	3/8" - 9/16"	450	0,75
26711-07-06	3/8" - 5/8"	350	0,83
26711-08-06	3/8" - 3/4"	250	0,92
26711-08-08	1/2" - 3/4"	250	0,93
26711-12-10	5/8" - 11/16"	125	2,21
26711-12-12	3/4" - 11/16"	100	1,86
26711-16-16	1" - 15/16"	50	3,27

UNF SOMUNLU 90° HORTUM RAKORU



Stok Kodu	Ölçü	Koli Adedi	Fiyat (USD)
26791-06-04	1/4" - 9/16"	250	1,26
26791-06-06	3/8" - 9/16"	250	1,26
26791-07-06	3/8" - 5/8"	250	1,50
26791-08-06	3/8" - 3/4"	200	1,70
26791-08-08	1/2" - 3/4"	125	1,70
26791-12-10	5/8" - 11/16"	50	4,19
26791-12-12	3/4" - 11/16"	50	3,40
26791-16-16	1" - 15/16"	25	6,13

BSP SOMUNLU DÜZ HORTUM RAKORU



Stok Kodu	Ölçü	Koli Adedi	Fiyat (USD)
22611-04-04	1/4" - 1/4"	500	0,72
22611-06-04	1/4" - 3/8"	500	1,04
22611-06-06	3/8" - 3/8"	350	0,82
22611-08-06	3/8" - 1/2"	250	1,33
22611-08-08	1/2" - 1/2"	250	1,07
22611-12-12	3/4" - 3/4"	125	1,86
22611-16-16	1" - 1"	60	3,27
22611-20-20	1 1/4" - 1 1/4"	35	5,79
22611-24-24	1 1/2" - 1 1/2"	30	7,08

BSP SOMUNLU 90° HORTUM RAKORU



Stok Kodu	Ölçü	Koli Adedi	Fiyat (USD)
22691-04-04	1/4" - 1/4"	300	1,18
22691-06-04	1/4" - 3/8"	250	1,58
22691-06-06	3/8" - 3/8"	250	1,36
22691-08-06	3/8" - 1/2"	125	2,13
22691-08-08	1/2" - 1/2"	125	1,85
22691-12-12	3/4" - 3/4"	60	3,40
22691-16-16	1" - 1"	30	6,13
22691-20-20	1 1/4" - 1 1/4"	15	10,55
22691-24-24	1 1/2" - 1 1/2"	10	17,17

Hat Tipi Komponentler

Model	Tip	Ölçü	Basınç (bar)	Fiyat (USD)
QC-105	 Otomatik Rakor	1"	250	35,00
QC-107		1 1/2"	220	96,00
DNB-12N	 Döner Bağlantı - Düz	1/2"	410	22,00
DNB-34N		3/4"	360	33,00
DNB-D-38N	 Döner Bağlantı - Dirsek	3/8"	450	22,00
DNB-D-12N		1/2"	410	26,00
DNB-D-34N		3/4"	360	48,00
KV3L-401	 Üç Yollu Vana	1/4"	500	28,00
CV-204	 Çek Valf	3/4"	380	16,00
CV-206		1 1/4"	350	39,00
TLV-301	 İkiz Kilitleme Valfi	1/4"	380	20,00
HPV-101	 Hortum Patlama Valfi	1/4"		17,00
HPV-104		3/4"		23,00
HPV-105		1"		42,00



PNÖMATİK



FIRETECH

FDNT Serisi ISO6431 Manyetik Yastıklı Silindirler



Silindir Çapı (mm)

	Ø32	Ø40	Ø50	Ø63	Ø80	Ø100	
Mil Çapı (mm) →	12	16	20	20	25	25	
"İtme kuvveti (kgf/6 bar) →"	48	75	118	187	301	471	
"Çekme kuvveti (kgf/6 bar) →"	41	63	99	168	272	442	
Strok (mm)	25	18,10	20,40	28,00	33,40	47,20	61,80
	50	18,10	20,60	28,60	34,20	49,20	63,80
	75	19,20	22,20	30,60	36,50	52,50	67,70
	100	20,30	23,90	32,70	38,80	55,70	71,70
	125	24,20	27,60	37,70	44,40	63,60	83,50
	150	24,20	27,60	37,70	44,40	63,60	83,50
	160	24,80	27,80	37,70	44,40	63,60	85,70
	200	25,70	30,20	41,00	48,10	68,80	87,20
	250	28,50	33,40	45,10	52,70	75,30	95,00
	300	31,20	36,60	49,30	57,20	81,90	102,80
	350	33,90	39,90	53,40	61,90	88,50	110,70
	400	36,60	43,10	57,50	66,60	95,00	118,40
	450	39,30	46,30	61,60	71,20	101,50	126,20
500	42,10	49,50	65,80	75,80	108,10	134,00	

Çalışma Basıncı: 1~9 bar
Dayanma Basıncı: 13,5 bar (max)
Çalışma Sıcaklığı: -5~70°C

Sipariş örneği: FDNT 63*75

FVBC Serisi ISO6431 Manyetik Yastıklı Silindirler



Silindir Çapı (mm)

	Ø32	Ø40	Ø50	Ø63	Ø80	Ø100	
Mil Çapı (mm) →	12	16	20	20	25	25	
"İtme kuvveti (kgf/6 bar) →"	48	75	118	187	301	471	
"Çekme kuvveti (kgf/6 bar) →"	41	63	99	168	272	442	
Strok (mm)	25	24,20	24,20	32,70	39,40	55,10	85,40
	50	25,90	32,80	42,10	52,30	65,90	89,10
	75	26,10	32,80	44,40	52,30	65,90	94,80
	100	27,30	37,10	46,80	57,00	80,00	99,40
	125	29,90	39,00	49,30	57,00	80,50	99,40
	150	30,90	40,90	52,10	65,40	88,70	109,10
	160	31,50	40,90	52,10	65,40	88,70	109,10
	200	31,50	44,10	52,10	65,40	95,90	118,20
	250	35,00	44,10	60,80	71,10	95,90	128,70
	300	38,10	49,80	66,10	75,90	104,70	138,90
	350	38,80	50,50	70,70	83,20	114,40	141,30
	400	42,10	56,50	75,50	90,40	124,20	152,90
	450	45,50	59,70	81,70	97,70	133,90	164,50
500	48,80	64,20	87,80	105,00	143,60	177,20	

Çalışma Basıncı: 1~9 bar
Dayanma Basıncı: 13,5 bar (max)
Çalışma Sıcaklığı: -5~70°C

Sipariş örneği: FVBC 63*75

RAL Serisi Sökülebilir Tip Manyetik Alüminyum Kalem Silindirler



Silindir Çapı (mm)

	Ø16	Ø20	Ø25	Ø32	
Mil Çapı (mm) →	6	8	10	12	
"İtme kuvveti (kgf/6 bar) →"	12,1	18,8	29,4	48,2	
"Çekme kuvveti (kgf/6 bar) →"	10,4	15,8	24,7	41,4	
Strok (mm)	10	11,50			
	20		13,90		
	25			18,00	
	40	15,50			
	50		13,90		18,60
	75	15,50		18,70	21,00
	100			18,70	21,40
	125	16,70	16,70		23,30
	150		16,70	19,10	26,00
	160		17,00		
	175	17,90	17,90	21,30	27,00
	200	19,00			28,50

Çalışma Basıncı: 1~9 bar
Dayanma Basıncı: 13,5 bar (max)
Çalışma Sıcaklığı: 0~70°C

Sipariş örneği: RAL 25*100

IAS Serisi ISO 6432 Sıvama Tip Mini Silindirler (Paslanmaz Borulu, Manyetik)



Silindir Çapı (mm)

		Ø12	Ø16	Ø20	Ø25
Mil Çapı (mm) →		6	6	8	10
"İtme kuvveti (kgf/6 bar) →"		6,8	12,1	18,8	29,4
"Çekme kuvveti (kgf/6 bar) →"		5,1	10,4	15,8	24,7
Strok (mm)	25	12,10	12,10	14,50	15,50
	30				16,20
	50	13,00	13,00	14,50	16,20
	75	13,30	13,30	14,50	17,00
	80	14,10	14,10	15,50	17,80
	100	14,10	14,10	15,50	17,80
	125	14,50	14,50	16,20	18,30
	150	15,50	15,50	17,20	19,50
	160		16,40	17,90	21,10
	175	16,40	16,40	17,90	21,10
	200	16,70	16,70	18,30	21,50

Çalışma Basıncı: 1~9 bar
Dayanma Basıncı: 13,5 bar (max)
Çalışma Sıcaklığı: 0~70°C

Sipariş örneği: IAS 25*175

SD Kısa Strok (Kompak Tip) Silindirler



Silindir Çapı (mm)

	Ø12	Ø16	Ø20	Ø25	Ø32	Ø40	Ø50	Ø63	Ø80	Ø100	
Mil Çapı (mm) →	6	6	8	10	12	16	20	20	25	32	
"İtme kuvveti (kgf/6 bar) →"	7	12	19	29	48	75	118	187	301	471	
"Çekme kuvveti (kgf/6 bar) →"	5	10	16	25	41	63	99	168	272	423	
Strok (mm)	5	9,50	9,90	10,10	12,70	14,10	16,70	21,40	25,00	36,10	48,30
	10	10,50	10,50	11,20	13,20	14,70	17,70	22,50	26,50	37,60	50,40
	15	11,00	11,00	12,10	13,60	15,60	18,10	23,90	28,00	39,20	51,90
	20	11,50	11,50	12,70	14,10	16,20	19,10	24,90	29,10	41,20	56,30
	25	12,00	12,00	13,20	15,20	17,20	20,20	25,90	30,50	42,70	56,30
	30	12,50	13,10	14,20	15,60	18,30	20,70	27,40	32,00	44,20	57,40
	35	13,10	14,10	14,70	16,70	18,70	21,70	28,50	33,10	45,70	59,40
	40	13,50	14,50	15,70	17,70	19,70	22,20	30,00	34,60	47,20	60,90
	45	14,10	15,50	16,20	18,30	20,30	23,30	31,00	36,10	48,70	64,60
	50	14,10	15,50	16,20	18,30	20,30	23,30	31,00	36,10	48,70	67,10

Çalışma Basıncı: 1~9 bar
Dayanma Basıncı: 10,5 bar (max)
Çalışma Sıcaklığı: 0~70°C

Sipariş örneği: SD 32*50

Döner Tabla Silindirleri



EMQ SERİSİ 0~190° Ayarlı, Döner Tabla Silindirleri

Tip	Fiyat (\$)
EMQB20S	147,00
EMQB70S	972,00
EMQB100S	1111,00

EMQ SERİSİ 0~190° Ayarlı, Şok Emicili Döner Tabla Silindirleri

Tip	Fiyat (\$)
EMQB20RS	172,00
EMQB50RS	384,00
EMQB70RS	1138,00
EMQB100RS	1300,00

MGPM Serisi, Üç Milli Silindir (Yataklı, Manyetik)



Silindir Çapı (mm)

		Ø16	Ø20	Ø25	Ø32	Ø40
Mil Çapı (mm) →		6	8	10	12	16
Strok (mm)	10	48,10	62,50			
	20	50,40	64,70	70,10		
	25	52,80	66,10	72,50	103,50	113,90
	30	52,80	66,10	72,50	103,50	113,90
	50	57,50	72,50	79,50	110,60	121,00
	75	67,70	80,80	91,50	132,80	144,80
	100	70,60	82,90	96,90	139,50	146,80
	150	77,90	98,30	114,60	161,50	170,20

Çalışma Basıncı : 1,2~10 bar
Dayanma Basıncı : 15 bar (max)
Çalışma Sıcaklığı : -10~60°C

Sipariş örneği: MGPM 25*75

TN Serisi, Çift Milli Silindir (Yataklı, Manyetik)



Silindir Çapı (mm)

		Ø16	Ø20	Ø25	Ø32
Mil Çapı (mm) →		6	8	10	12
Strok (mm)	10	24,50	29,70	39,00	57,20
	20	25,40	31,20	40,40	59,50
	25	26,30	32,60	41,60	61,80
	30	26,30	32,60	41,60	61,80
	50	27,10	34,10	43,30	64,10
	75	30,40	36,80	47,30	71,60
	80	31,50	39,50	50,50	75,00
	100	34,90	43,60	56,30	83,70
	150	38,40	47,60	62,10	92,40

Çalışma Basıncı : 1~9 bar
Dayanma Basıncı : 10,5 bar (max)
Çalışma Sıcaklığı : -5~70°C

Sipariş örneği: TN 25*75

FVBC Tipi Silindir Montaj Malzemeleri



VB - Hareketli Mafsal

Kod	Açıklama	Fiyat (USD)
VB-D10	M4 - Ø10	2,00
VB-D11	M5x0,8 - Ø10	2,00
VB-D12/D16	M6x1 - Ø12/Ø16	2,00
VB-D20	M8x1,25 - Ø20	2,25
VB-D25/D32	M10x1,25 - Ø25/Ø32	2,70
VB-D40	M12x1,25 - Ø40	3,60
VB-D41 (Kalın Diş)	M12x1,5 - Ø40 (ÖZEL)	3,60
VB-D63	M16x1,5 - Ø50/Ø63	5,80
VB-D80/D100	M20x1,5 - Ø80/Ø100	9,50
VB-D125	M27x2,0 - Ø125	30,30
VB-D200	M36*2,0 - Ø160/Ø200	NET FİYAT 17,50

FVBC Tipi Silindir Montaj Malzemeleri



VYC - Klipsli Çatal

Kod	Açıklama	Fiyat (USD)
VYC-D12/D16	M6x1 - Ø12/Ø16	2,50
VYC-D20	M8x1,25 - Ø20	2,95
VYC-D25/D32	M10x1,25 - Ø25/Ø32	4,20
VYC-D40	M12x1,25 - Ø40	5,85
VYC-D50/D63	M16x1,5 - Ø50/Ø63	9,10
VYC-D80/D100	M20x1,5 - Ø80/Ø100	15,80
VYC-D125	M27x2,0 - Ø125	47,25
VY-D200	M36x2,0 - Ø160/Ø200	62,50
VY-D250	M42x2,0 - Ø250	NET FİYAT 58,76



VCR Yer Bağlantısı

Kod	Açıklama	Fiyat (USD)
VCR-D32	Ø32	4,20
VCR-D40	Ø40	4,20
VCR-D50	Ø50	6,05
VCR-D63	Ø63	12,10
VCR-D80	Ø80	17,85
VCR-D100	Ø100	15,35
VCR-D125	Ø125	25,55
VCR-D200	Ø200	162,70

** VCB tipi eklem bağlantısı ile kullanılabilir.

FVBC Tipi Silindir Montaj Malzemeleri



VCB Eklem Bağlantı

Kod	Açıklama	Fiyat (USD)
VCB-D32	Ø32	3,30
VCB-D40	Ø40	3,80
VCB-D50	Ø50	5,30
VCB-D63	Ø63	6,10
VCB-D80	Ø80	10,00
VCB-D100	Ø100	13,15
VCB-D125	Ø125	25,00
VCB-D160	Ø160	NET FİYAT 17,50
VCB-D200	Ø200	NET FİYAT 27,54



VF - Kasıntı Alıcı

Kod	Açıklama	Fiyat (USD)
VF-D32	Ø32 - M10x1,25	6,70
VF-D40	Ø40 - M12x1,25	7,70
VF-D50/D63	Ø50/Ø63 - M16x1,5	13,30
VF-D80/D100	Ø80/Ø100 - M20x1,5	19,70

** Pimli Tip, VCR yer bağlantısı ile kullanılabilir



VCA Eklem Bağlantı

Kod	Açıklama	Fiyat (USD)
VCA-D32	Ø32	2,90
VCA-D40	Ø40	3,25
VCA-D50	Ø50	4,10
VCA-D63	Ø63	5,05
VCA-D80	Ø80	7,40
VCA-D100	Ø100	11,90
VCA-D125	Ø125	NET FİYAT 5,77
VCA-D160	Ø160	NET FİYAT 14,58
VCA-D200	Ø200	NET FİYAT 23,33



VFA - Flanş Bağlantı

Kod	Açıklama	Fiyat (USD)
VFA-D32	Ø32	5,70
VFA-D40	Ø40	7,00
VFA-D50	Ø50	8,30
VFA-D63	Ø63	11,25
VFA-D80	Ø80	20,00
VFA-D100	Ø100	20,70
VFA-D125	Ø125	NET FİYAT 11,92
VFA-D160	Ø160	50,80
VFA-D200	Ø200	NET FİYAT 26,57

FVBC Tipi Silindir Montaj Malzemeleri



VLB - Ayak Bağlantı

Kod	Açıklama	Fiyat (USD)
VLB-D32	Ø32	1,10
VLB-D40	Ø40	1,55
VLB-D50	Ø50	2,20
VLB-D63	Ø63	3,30
VLB-D80	Ø80	3,80
VLB-D100	Ø100	4,35
VLB-D125	Ø125	NET FİYAT 2,64
VLB-D160	Ø160	NET FİYAT 6,35
VLB-D200	Ø200	NET FİYAT 10,87

IAS Tipi Silindir Montaj Malzemeleri



ISDB - Eklem Bağlantı

Kod	Açıklama	Fiyat (USD)
ISDB-12	Ø12	3,85

FA-FB - Flanş Bağlantı

Kod	Açıklama	Fiyat (USD)
IAS16 FA-FB	Ø16	2,40



VI - Çatal Bağlantı

Kod	Açıklama	Fiyat (USD)
VI-16	Ø16	1,95



Manyetik Sensörler



Tanımı	Model	Fotoğraf	Fiyat (\$)
FVBC TİP SİLİNDİRLER İÇİN	HX-31R(Reed Switch)		5,00
IAS VE RAL TİPİ SİLİNDİRLER İÇİN	HX-03R (Reed S. 1mt.)		6,60
	HX-03R (Reed S. 3mt.)		6,50
	HX-03P(PNP)	21,80	
	HX-15R(Reed Switch)		7,70
SD TİP SİLİNDİRLER İÇİN	CS1-J (Reed Switch)		6,40
VBC TİP SİLİNDİRLER İÇİN	HX-21R(Reed Switch)		5,40
	HX-21P (PNP)		17,50

V Serisi Elektrik Uyarılı Yön Kontrol Valfleri



3/2 Tek Bobin Valfler

Kod	Açıklama	Fiyat (USD)
V3211-06	1/8" - 3/2 Tek Bobin	17,90
V3221-08	1/4" - 3/2 Tek Bobin	15,00
V3221-08H	1/4" - 3/2 Tek Bobin (NA)	16,40
V3231-08	1/4" - 3/2 Tek Bobin - Geniş Gövde	22,10
V3231-10	3/8" - 3/2 Tek Bobin	22,10
V3241-15	1/2" - 3/2 Tek Bobin	35,00
V3241-15H	1/2" - 3/2 Tek Bobin (NA)	43,90

5/2 Tek Bobin Valfler

Kod	Açıklama	Fiyat (USD)
V5211-06	1/8" - 5/2 Tek Bobin	20,50
V5221-06	1/8" - 5/2 Tek Bobin - Geniş Gövde	22,70
V5221-08	1/4" - 5/2 Tek Bobin	15,10
V5231-08	1/4" - 5/2 Tek Bobin - Geniş Gövde	25,10
V5231-10	3/8" - 5/2 Tek Bobin	25,10
V5241-15	1/2" - 5/2 Tek Bobin	35,90
V5221-06F	1/8" - 5/2 Tek Bobin - Kablolu Tip (Geniş Gövde)	19,30
V5221-08F	1/4" - 5/2 Tek Bobin - Kablolu Tip	19,30

* Lütfen siparişinizde model kodundan sonra voltaj kodunu ekleyiniz. 24 VDC için "E4", 220 VAC için "E2".

* Fiyatlara bobin ve ışıklı soketler DAHİLDİR

Çalışma Basıncı : 1.5~8 bar

Dayanma Basıncı: 12 bar (max)

Çalışma Sıcaklığı : 5~50°C

Güç Tüketimi : AC-2.5VA / DC-2.5W (1/8" Gövde)

AC-4.5VA / DC-3W (1/4", 3/8" ve 1/2" Gövde)"

Frekans : 20 Hz (max)

V Serisi Elektrik Uyarılı Yön Kontrol Valfleri



5/2 Çift Bobin Valfler

Kod	Açıklama	Fiyat (USD)
V5212-06	1/8" - 5/2 Çift Bobin	29,80
V5222-08	1/4" - 5/2 Çift Bobin	26,90
V5232-08	1/4" - 5/2 Çift Bobin - Geniş Gövde	35,90
V5232-10	3/8" - 5/2 Çift Bobin	35,90
V5242-15	1/2" - 5/2 Çift Bobin	47,80

5/3 Çift Bobin Valfler

Kod	Açıklama	Fiyat (USD)
V5312-06C	1/8" - 5/3 Çift Bobin - Kapalı M.	44,80
V5322-08C	1/4" - 5/3 Çift Bobin - Kapalı M.	42,00
V5332-08C	1/4" - 5/3 Çift Bobin - Kapalı M.(Geniş Gövde)	48,70
V5332-10C	3/8" - 5/3 Çift Bobin - Kapalı M.	48,70
V5342-15C	1/2" - 5/3 Çift Bobin - Kapalı M.	59,70
V5312-06P	1/8" - 5/3 Çift Bobin - Basınç M.	46,90
V5322-08P	1/4" - 5/3 Çift Bobin - Basınç M.	50,60
V5332-10P	3/8" - 5/3 Çift Bobin - Basınç M.	68,40
V5342-15P	1/2" - 5/3 Çift Bobin - Basınç M.	72,90
V5312-06E	1/8" - 5/3 Çift Bobin - Egzoz M.	46,90
V5322-08E	1/4" - 5/3 Çift Bobin - Egzoz M.	50,60
V5332-10E	3/8" - 5/3 Çift Bobin - Egzoz M.	68,40
V5342-15E	1/2" - 5/3 Çift Bobin - Egzoz M.	72,90

* Lütfen siparişinizde model kodundan sonra voltaj kodunu ekleyiniz. 24 VDC için "E4", 220 VAC için "E2".

* Fiyatlara bobin ve ışıklı soketler DAHİLDİR

Çalışma Basıncı : 1.5~8 bar

Dayanma Basıncı : 12 bar (max)

Çalışma Sıcaklığı : 5~50°C

Güç Tüketimi " : AC-2.5VA / DC-2.5W (1/8" Gövde)

AC-4.5VA / DC-3W (1/4", 3/8" ve 1/2" Gövde)"

Frekans : 20 Hz (max)

V Serisi Namur Valfleri



Namur Valfler

Kod	Açıklama	Fiyat (USD)
V3231-08M	1/4" - 3/2 Tek Bobin - Geniş Gövde	30,40
V5221-08M	1/4" - 5/2 Tek Bobin	15,50
V5231-08M	1/4" - 5/2 Tek Bobin - Geniş Gövde	24,80
V5232-08M	1/4" - 5/2 Çift Bobin - Geniş Gövde	35,80

* Lütfen namur valfler için, siparişinizde model kodundan sonra voltaj kodunu ekleyiniz. 24 VDC için "E4", 220 VAC için "E2".

* Fiyatlara bobin ve ışıklı soketler DAHİLDİR

V Serisi Hava Uyarılı Yön Kontrol Valfleri



3/2 - 5/2 - Hava Uyarılı Valfler

Kod	Açıklama	Fiyat (USD)
V3211-06A	1/8" - 3/2 Hava-Yay	14,80
V3221-06A	1/8" - 3/2 Hava-Yay - Geniş Gövde	14,10
V3221-08A	1/4" - 3/2 Hava-Yay	12,00
V3231-10A	3/8" - 3/2 Hava-Yay	24,60
V3241-15A	1/2" - 3/2 Hava-Yay	34,80
V5211-06A	1/8" - 5/2 Hava-Yay	13,40
V5221-06A	1/8" - 5/2 Hava-Yay - Geniş Gövde	13,80
V5221-08A	1/4" - 5/2 Hava-Yay	12,50
V5231-08A	1/4" - 5/2 Hava-Yay - Geniş Gövde	21,70
V5231-10A	3/8" - 5/2 Hava-Yay	21,70
V5241-15A	1/2" - 5/2 Hava-Yay	37,60
V5212-06A	1/8" - 5/2 Hava-Hava	22,40
V5222-08A	1/4" - 5/2 Hava-Hava	17,50
V5232-10A	3/8" - 5/2 Hava-Hava	27,00
V5242-15A	1/2" - 5/2 Hava-Hava	39,10

Çalışma Basıncı : 1.5~8 bar

Dayanma Basıncı : 12 bar (max)

Çalışma Sıcaklığı : 5~50°C

Frekans : 20 Hz (max)

V Serisi Hava Uyarılı Yön Kontrol Valfleri



5/3 - Hava Uyarılı Valfler

Kod	Açıklama	Fiyat (USD)
V5312-06AC	1/8" - 5/3 Hava-Hava Kapalı M.	37,70
V5322-08AC	1/4" - 5/3 Hava-Hava Kapalı M.	31,30
V5332-10AC	3/8" - 5/3 Hava-Hava Kapalı M.	NET FİYAT 10,08
V5342-15AC	1/2" - 5/3 Hava-Hava Kapalı M.	79,00
V5312-06AP	1/8" - 5/3 Hava-Hava Basınç M.	37,70
V5322-08AP	1/4" - 5/3 Hava-Hava Basınç M.	31,30
V5332-10AP	3/8" - 5/3 Hava-Hava Basınç M.	46,40
V5342-15AP	1/2" - 5/3 Hava-Hava Basınç M.	79,00
V5312-06AE	1/8" - 5/3 Hava-Hava Egzoz M.	37,70
V5322-08AE	1/4" - 5/3 Hava-Hava Egzoz M.	31,30
V5332-10AE	3/8" - 5/3 Hava-Hava Egzoz M.	46,40
V5342-15AE	1/2" - 5/3 Hava-Hava Egzoz M.	79,00

Çalışma Basıncı : 1.5~8 bar

Dayanma Basıncı : 12 bar (max)

Çalışma Sıcaklığı : 5~50°C

Frekans : 20 Hz (max)

CN Serisi Düşük Güç/ Yüksek Frekans Valfleri



Kod	Açıklama	Fiyat (USD)
CN2V251E4-08	1/4" - 5/2 Tek Bobin 24VDC	18,10

Valf Yedek Parçaları



Zamanlayıcı

Kod	Açıklama	Fiyat (USD)
PUT	Zamanlayıcı	15,90



Valf Bobini (Işıklı Soket Dahil)

Kod	Açıklama	Fiyat (USD)
VC1-DT	Valf Bobini - 1/8" gövde için (Ø8x23,5mm)	7,00
VC2-DT	Valf Bobini - 1/4", 3/8", 1/2" gövde için(Ø9x29mm)	5,20

* Lütfen siparişinizde model kodundan sonra voltaj belirtiniz. 12, 24 ve 220 volt AC/DC bobinler stoklarımızda mevcuttur.



Enerji Tasarruf Modülü

Kod	Açıklama	Fiyat (USD)
ESH2DC-B75	Enerji Tasarruf Modülü - 24VDC	10,50

ESH2DC-B75 Enerji Tasarruf Modülü, özellikle solenoid valflerde görülen yüksek güç tüketimi, ısınma problemleri ve buna bağlı olarak parça ömründeki kısalmalara çözüm getiriyor. Tüm marka ve çaplarda kullanılabilen Enerji Tasarruf Modülü(Multi Core Integrator), tepki hızını yüzde 30 oranında artırırken, bobin ısınmasını da yüzde 50 oranında azaltıyor. Tüm 24VDC Elektrik uyarılı valfler ile uyumludur

V serisi Valfler için Manifoltlar



	SIRALI	1/8"		1/4"		3/8"		1/2"	
		Model	Fiyat	Model	Fiyat	Model	Fiyat	Model	Fiyat
MANIFOLT 3/2 Valf ler için	2	V321-2F	6,90	V322-2F	5,50	V323-2F	14,00	V324-2F	17,10
	3	V321-3F	10,20	V322-3F	9,00	V323-3F	20,20	V324-3F	28,40
	4	V321-4F	16,10	V322-4F	12,30	V323-4F	27,30	V324-4F	38,40
	5	V321-5F	18,50	V322-5F	12,90	V323-5F	33,40	V324-5F	50,30
	6	V321-6F	24,00	V322-6F	18,50	V323-6F	34,30	V324-6F	57,60
	7	V321-7F	28,10	V322-7F	19,00	V323-7F	36,70	V324-7F	78,90
	8	V321-8F	31,90	V322-8F	22,60	V323-8F	43,20	V324-8F	89,50
	9	V321-9F	36,00	V322-9F	23,10	V323-9F	50,00	V324-9F	100,50
	10	V321-10F	39,80	V322-10F	25,00	V323-10F	67,20	V324-10F	110,70

	SIRALI	1/8"		1/4"		3/8"		1/2"	
		Model	Fiyat	Model	Fiyat	Model	Fiyat	Model	Fiyat
MANIFOLT 5/2 ve 5/3 Valf ler için	2	V521-2F	5,20	V522-2F	5,20	V523-2F	8,90	V524-2F	17,30
	3	V521-3F	7,70	V522-3F	7,00	V523-3F	15,20	V524-3F	24,90
	4	V521-4F	11,40	V522-4F	10,30	V523-4F	20,50	V524-4F	38,40
	5	V521-5F	12,90	V522-5F	12,90	V523-5F	21,40	V524-5F	50,30
	6	V521-6F	16,60	V522-6F	16,70	V523-6F	25,80	V524-6F	60,20
	7	V521-7F	20,50	V522-7F	17,90	V523-7F	30,00	V524-7F	83,30
	8	V521-8F	20,50	V522-8F	21,90	V523-8F	34,30	V524-8F	95,30
	9	V521-9F	25,60	V522-9F	23,10	V523-9F	38,60	V524-9F	107,10
	10	V521-10F	25,60	V522-10F	24,20	V523-10F	42,90	V524-10F	119,00

Not: Sızdırmazlık contası ve civatalar DAHİLDİR.

Mekanik Valfler

Tanımlı	Fotograf	Model	Fiyat (\$)
1/4" - 3/2 Mekanik Uyarılı Valfler		M322-S1	19,80
		M322-S2	
		M322-S3	
		M322-S4	
		M322-S5	
		M322-S6	
1/4" - 5/2 Mekanik Uyarılı Valfler		M522-S1	18,50
		M522-S2	
		M522-S3	
		M522-S4	
		M522-S5	
		M522-S6	

L Serisi Mekanik Kumandalı Valfler



Kod	Açıklama	Fiyat (USD)
L321-06	1/8" - 3/2 Kalmalı Tip	17,10
L322-08	1/4" - 3/2 Kalmalı Tip	15,50
L323-08	1/4" - 3/2 Kalmalı Tip - Geniş Gövde	22,50
L323-10	3/8" - 3/2 Kalmalı Tip	22,50
L324-15	1/2" - 3/2 Kalmalı Tip	28,60
L521-06	1/8" - 5/2 Kalmalı Tip	18,70
L522-08	1/4" - 5/2 Kalmalı Tip	15,70
L523-08	1/4" - 5/2 Kalmalı Tip - Geniş Gövde	23,10
L523-10	3/8" - 5/2 Kalmalı Tip	23,10
L524-15	1/2" - 5/2 Kalmalı Tip	31,70

Çalışma Basıncı : 1.5~8 bar
Dayanma Basıncı : 12 bar (max)
Çalışma Sıcaklığı : -5~80°C

H Serisi Mekanik Kumandalı Valfler



3/2 - 5/2 Kol Kumandalı (Kalmalı Tip)

Kod	Açıklama	Fiyat (USD)
H321-06	1/8" - 3/2 Kol-Kol	21,40
H322-08	1/4" - 3/2 Kol-Kol	17,90
H323-08	1/4" - 3/2 Kol-Kol - Geniş Gövde	25,50
H323-10	3/8" - 3/2 Kol-Kol	25,50
H324-15	1/2" - 3/2 Kol-Kol	31,60
H521-06	1/8" - 5/2 Kol-Kol	20,80
H522-08	1/4" - 5/2 Kol-Kol	16,90
H523-08	1/4" - 5/2 Kol-Kol - Geniş Gövde	21,80
H523-10	3/8" - 5/2 Kol-Kol	21,80
H524-15	1/2" - 5/2 Kol-Kol	34,50

5/3 Kol Kumandalı (Kalmalı Tip-KM)

Kod	Açıklama	Fiyat (USD)
H531-06C	1/8" - 5/3 Kol-Kol	33,00
H532-08C	1/4" - 5/3 Kol-Kol	33,40
H533-08C	1/4" - 5/3 Kol-Kol - Geniş Gövde	41,90
H533-10C	3/8" - 5/3 Kol-Kol	41,90
H534-15C	1/2" - 5/3 Kol-Kol	50,00

Çalışma Basıncı : 1.5~8 bar

Dayanma Basıncı : 12 bar (max)

Çalışma Sıcaklığı : -5~80°C

H Serisi Mekanik Kumandalı Valfler



3/2 - 5/2 Kol Kumandalı (Yay geri dönüşlü)

Kod	Açıklama	Fiyat (USD)
H322-08S	1/4" - 3/2 Kol-Yay	19,00
H521-06S	1/8" - 5/2 Kol-Yay	22,10
H522-08S	1/4" - 5/2 Kol-Yay	17,90
H523-08S	1/4" - 5/2 Kol-Yay - Geniş Gövde	35,90
H523-10S	3/8" - 5/2 Kol-Yay	35,90
H524-15S	1/2" - 5/2 Kol-Yay	40,50



5/3 Kol Kumandalı (Yay geri dönüşlü-KM)

Kod	Açıklama	Fiyat (USD)
H531-06S	1/8" - 5/3 Kol-Yay	32,50
H532-08S	1/4" - 5/3 Kol-Yay	33,10
H533-08S	1/4" - 5/3 Kol-Yay - Geniş Gövde	40,70
H533-10S	3/8" - 5/3 Kol-Yay	40,70
H534-15S	1/2" - 5/3 Kol-Yay	50,00

Çalışma Basıncı : 1.5~8 bar
Dayanma Basıncı : 12 bar (max)
Çalışma Sıcaklığı : -5~80°C

Pedal ve Kol Kumandalı Çevirmeli Valfler



Pedal Valfler

Kod	Açıklama	Fiyat (USD)
FV320	1/4" - 3/2 Pedal Valf - Mini Tip	19,70
FV420	1/4" - 5/2 Pedal Valf - Mini Tip	22,40
F522-08	1/4" - 5/2 Pedal Valf	30,70
F522-08L	1/4" - 5/2 Pedal Valf (Kilitli)	33,50
F522C-08	1/4" - 5/2 Pedal Valf (Muhafazalı)	39,10



U432



R432



M432/MR432

Kol Kumandalı Çevirmeli Valfler

Kod	Açıklama	Fiyat (USD)
R432-08	1/4" - 4/3 Çevirmeli Valf (4x1 yandan çıkış)	27,30
R432-10	3/8" - 4/3 Çevirmeli Valf (4x1 yandan çıkış)	27,30
R432-15	1/2" - 4/3 Çevirmeli Valf (4x1 yandan çıkış)	27,30
U432-08	1/4" - 4/3 Çevirmeli Valf (2+1 yandan, egzoz alttan)	27,30
M432-08	1/4" - 4/3 Çevirmeli Valf (2x2 yandan çıkış)	27,30
MR432-08	1/4" - 4/3 Çevirmeli Valf - Seramik Keçeli (4x1 yandan)	43,90
MR432-10	3/8" - 4/3 Çevirmeli Valf - Seramik Keçeli (4x1 yandan)	43,90
MR432-15	1/2" - 4/3 Çevirmeli Valf - Seramik Keçeli (4x1 yandan)	43,90

Hat Tip Pnömatik Valfler



Hat Tipi Çek Valf

Kod	Açıklama	Fiyat (USD)
EA-06	Çek Valf, G1/8	8,20
EA-08	Çek Valf, G1/4	9,70
EA-10	Çek Valf, G3/8	17,90
EA-15	Çek Valf, G1/2	17,90



Çabuk Egzoz Valfi

Kod	Açıklama	Fiyat (USD)
KKP-06	Çabuk Egzoz, G1/8	16,90
KKP-08	Çabuk Egzoz, G1/4	16,90
KKP-10	Çabuk Egzoz, G3/8	19,10
KKP-15	Çabuk Egzoz, G1/2	25,50



VEYA Valfi

Kod	Açıklama	Fiyat (USD)
ES-06	VEYA valfi, G1/8	14,60
ES-08	VEYA valfi, G1/4	14,60
ES-10	VEYA valfi, G3/8	NET FİYAT 5,31
ES-15	VEYA valfi, G1/2	NET FİYAT 5,48



Hız Ayar Valfi (Çekli)

Kod	Açıklama	Fiyat (USD)
RE-01	Hız Ayar, G1/8	5,60
RE-02	Hız Ayar, G1/4	6,50
RE-03	Hız Ayar, G3/8	8,40
RE-04	Hız Ayar, G1/2	8,40



Slide Valf

Kod	Açıklama	Fiyat (USD)
YHS-06	Slide Valf, G1/8	6,50
YHS-08	Slide Valf, G1/4	7,60
YHS-10	Slide Valf, G3/8	14,40
YHS-15	Slide Valf, G1/2	17,90

F Serisi Şartlandırıcılar

İkili Şartlandırıcı (Filtre-Regülatör-Yağlayıcı FR+L)

Fotograf	Kod	Ölçü	Fiyat (USD)
	FEC 1/8" MINI	1/8" MINI	82,70
	FEC 1/4" MINI	1/4" MINI	86,60
	FEC 1/4" D MINI	1/4" MINI (O.T.) *	123,50
	FEC 3/8" MIDI	3/8" MIDI	139,40
	FEC 1/2" MIDI	1/2" MIDI	145,80
	FEC 3/8" D MIDI	3/8" MIDI (O.T.) *	186,90
	FEC 1/2" D MIDI	1/2" MIDI (O.T.) *	186,90
	FEC 3/4" MAXI	3/4" MAXI	234,00
	FEC 1" MAXI	1" MAXI	234,00

* O.T. : Otomatik Tahliyeli

Filtre-Regülatör (FR)

Fotograf	Kod	Ölçü	Fiyat (USD)
	FEW 1/8" MINI	1/8" MINI	52,80
	FEW 1/4" MINI	1/4" MINI	52,80
	FEW 1/4" MIDI	1/4" MIDI	95,00
	FEW 3/8" MIDI	3/8" MIDI	95,00
	FEW 1/2" MIDI	1/2" MIDI	95,00
	FEW 3/4" MAXI	3/4" MAXI	152,60
	FEW 1" MAXI	1" MAXI	152,60

Regülatör Ayar Basıncı : 0.5~12 bar

Max. Giriş Basıncı : 16 bar

Çalışma Sıcaklığı : 5~60°C

Filtre Hassasiyeti : 40 µm

F Serisi Şartlandırıcılar

Filtre

Fotograf	Kod	Ölçü	Fiyat (USD)
	FEF 1/8" MINI	1/8" MINI	31,10
	FEF 1/4" MINI	1/4" MINI	
	FEF 3/8" MIDI	3/8" MIDI	55,40
	FEF 1/2" MIDI	1/2" MIDI	
	FEF 3/4" MAXI	3/4" MAXI	103,60
	FEF 1" MAXI	1" MAXI	

Yağlayıcı

Fotograf	Kod	Ölçü	Fiyat (USD)
	FEL 1/8" MINI	1/8" MINI	33,90
	FEL 1/4" MINI	1/4" MINI	33,90
	FEL 3/8" MIDI	3/8" MIDI	58,40
	FEL 1/2" MIDI	1/2" MIDI	58,40
	FEL 3/4" MAXI	3/4" MAXI	110,20
	FEL 1" MAXI	1" MAXI	110,20

Regülatör Ayar Basıncı : 0.5~12 bar
Max. Giriş Basıncı : 16 bar
Çalışma Sıcaklığı : 5~60°C
Filtre Hassasiyeti : 40 µm

Regülatör

Fotograf	Kod	Ölçü	Fiyat (USD)
	FER 1/8 MINI	1/8" MINI	40,60
	FER 1/4 MINI	1/4" MINI	40,60
	FER 1/4 MIDI	1/4" MIDI	76,20
	FER 3/8 MIDI	3/8" MIDI	75,40
	FER 1/2 MIDI	1/2" MIDI	75,40
	FER 3/4 MAXI	3/4" MAXI	123,40
	FER 1 MAXI	1" MAXI	123,40

Regülatör Ayar Basıncı : 0.5~12 bar
Max. Giriş Basıncı : 16 bar
Çalışma Sıcaklığı : 5~60°C
Filtre Hassasiyeti : 40 µm

F Serisi Şartlandırıcılar

Otomatik Tahliye Kiti

Fotograf	Kod	Ölçü	Fiyat (USD)
	AUTH.DR.KIT F SER.MINI	1/8" MINI	49,30
	AUTH.DR.KIT F SER.MIDI	1/4" MINI	49,30

Yüksek Basınç Şartlandırıcıları

Filtre-Regülatör (40 Bar)

Fotograf	Kod	Ölçü	Fiyat (USD)
	FRH08	1/4"	240,70
	FRH10	3/8"	240,70
	FRH15	1/2"	240,70
	FRH20	3/4"	403,80

Regülatör (40 Bar)

Fotograf	Kod	Ölçü	Fiyat (USD)
	FTHY08	1/4"	72,90
	FTHY10	3/8"	72,90
	FTHY15	1/2"	72,90
	FTHY20	3/4"	94,40

Regülatör Ayar Basıncı : 0.5~30 bar

Max. Giriş Basıncı : 40 bar

Çalışma Sıcaklığı : 5~60°C

Filtre Hassasiyeti : 40 µm

Otomatik Boşaltma

Fotograf	Kod	Ölçü	Fiyat (USD)
	HAD402	1/2"	67,00

Max. Giriş Basıncı : 10 bar

Çalışma Sıcaklığı : 5~60°C

Yuvarlak Tip Şartlandırıcılar

İkili Şartlandırıcı (Filtre-Regülatör-Yağlayıcı FR+L)

Fotoğraf	Kod	Ölçü	Fiyat (USD)
	AEFC2000	1/4"	30,60
	BEFC3000	3/8"	55,80
	BEFC4000	1/2"	56,50

Filtre-Regülatör (FR)

Fotoğraf	Kod	Ölçü	Fiyat (USD)
	AFR2000	1/4"	21,20
	BEFR3000	3/8"	33,50
	BEFR4000	1/2"	33,50

Filtre

Fotoğraf	Kod	Ölçü	Fiyat (USD)
	AEF2000	1/4"	12,80
	BEF3000	3/8"	28,80
	BEF4000	1/2"	28,80

Yağlayıcı

Fotoğraf	Kod	Ölçü	Fiyat (USD)
	AEL2000	1/4"	16,70
	BEL3000	3/8"	30,70
	BEL4000	1/2"	30,70

Regülatör

Fotoğraf	Kod	Ölçü	Fiyat (USD)
	AER2000	1/4"	15,20
	BER3000	3/8"	22,30
	BER4000	1/2"	22,30

* Tüm filtreler yarı-otomatik tahliyelidir.
Regülatör Ayar Basıncı : 0,5~8,5 bar
Max. Giriş Basıncı : 9,5 bar
Çalışma Sıcaklığı : 5~60°C
Filtre Hassasiyeti : 40 µm

Kare Tip Şartlandırıcılar

İkili Şartlandırıcı (Filtre-Regülatör-Yağlayıcı FR+L)

Fotograf	Kod	Ölçü	Fiyat (USD)
	EC2010-01	1/8"	50,20
	EC2010-02	1/4"	50,20
	EC3010-03	3/8"	75,70
	EC4010-04	1/2"	108,80
	EC5010-06	3/4"	175,80
	EC5010-10	1"	175,80

Üçlü Şartlandırıcı (Filtre-Regülatör-Yağlayıcı F+R+L)

Fotograf	Kod	Ölçü	Fiyat (USD)
	EIC2000-01	1/8" - Büyük Gövde	27,00

Filtre-Regülatör (FR)

Fotograf	Kod	Ölçü	Fiyat (USD)
	EW2000-02	1/4"	36,30
	EW3000-03	3/8"	50,20
	EW4000-04	1/2"	75,30
	EW5000-06	3/4"	117,20
	EIW5000-10	1"	50,55
	EW5000-10	1"	117,20

Filtre

Fotograf	Kod	Ölçü	Fiyat (USD)
	EF2010-02	1/4"	16,70
	EF3010-03	3/8"	25,10
	EF4010-04	1/2"	39,10
	EF5010-06	3/4"	61,40
	EF5010-10	1"	61,40

* Tüm filtreler yarı-otomatik tahliyelidir.
Regülatör Ayar Basıncı : 0.5~8.5 bar
Max. Giriş Basıncı : 10 bar
Çalışma Sıcaklığı : 5~60°C
Filtre Hassasiyeti : 5 µm

Kare Tip Şartlandırıcılar

Yağlayıcı

Fotoğraf	Kod	Ölçü	Fiyat (USD)
	EL2000-01	1/8"	7,00
	EIL2000-02	1/4"	6,70
	EL804-02	1/4"	8,00
	EL2010-02	1/4"	14,00
	EIL3000-02	1/4" - Büyük Gövde	9,90
	EL3010-03	3/8"	25,10
	EL4010-04	1/2"	36,30
	EL5010-06	3/4"	67,00
	EL5010-10	1"	67,00

Regülatör

Fotoğraf	Kod	Ölçü	Fiyat (USD)
	ER2000-02	1/4"	22,30
	ER3000-03	3/8"	41,90
	ER4000-04	1/2"	45,40
	ER5000-06	3/4"	69,80
	ER5000-10	1"	69,80

Regülatör Ayar Basıncı : 0.5~8.5 bar
Max. Giriş Basıncı : 10 bar
Çalışma Sıcaklığı : 5~60°C
Filtre Hassasiyeti : 5 µm

Genel Maksat Valfleri

SLP Serisi Solenoid Valfler (NK)

Fotograf	Ölçü	Orifis (mm)	Keçe	Gövde Malz.	Model	Fiyat (USD)
	1/8"	3	0~13	Soketli	SLP06-3L	44,40
	1/4"	3	NBR	Pirinç	SLP08-3L	51,20
	3/8"	10.5	NBR	Pirinç	SLP10-10,5L	52,90
	1/2"	13	NBR	Pirinç	SLP15-13L	87,90
	3/4"	20	NBR	Pirinç	SLP20-20L	92,30
	1"	25	NBR	Pirinç	SLP25-25L	143,90
	1-1/4"	35	NBR	Pirinç	SLP35-35L	239,20
	1-1/2"	40	NBR	Pirinç	SLP40-40L	246,50
	2"	50	NBR	Pirinç	SLP50-50L	370,00
	29x38.5x42(EBY)	Ø14,7		Yedek Bobin	BOBİN - SLPC-220VAC	23,60
29x38.5x42(EBY)	Ø14,7		Yedek Bobin	BOBİN - SLPC-24VDC	23,60	
Yedek Diyafram				SLP15ND - NBR	2,35	
Yedek Diyafram				SLP20ND - NBR	2,95	
Yedek Diyafram				SLP20VD - VİTON	7,05	
Yedek Diyafram				SLP25ND - NBR	3,50	
Yedek Diyafram				SLP25VD - VİTON	17,50	

** Paslanmaz SS316 olarak stokta mevcuttur, lütfen fiyat sorunuz

SLP-H Serisi Solenoid Valfler (NA)

Fotograf	Ölçü	Orifis (mm)	Keçe	Gövde Malzemesi	Model	Fiyat (USD)
	1/8"	3	NBR	Pirinç	SLP06-3LH	67,60
	1/4"	3	NBR	Pirinç	SLP08-3LH	74,30
	3/8"	13	NBR	Pirinç	SLP10-13LH	90,80
	1/2"	13	NBR	Pirinç	SLP15-13LH	108,50
	3/4"	20	NBR	Pirinç	SLP20-20LH	122,20
	1"	25	NBR	Pirinç	SLP25-25LH	170,80
	1-1/4"	35	NBR	Pirinç	SLP35-35LH	280,40
	1-1/2"	40	NBR	Pirinç	SLP40-40LH	280,40
	2"	50	NBR	Pirinç	SLP50-50LH	418,20

EMC Serisi 2/2 Solenoid Valfler (NK)

Fotograf	Ölçü	Orifis (mm)	Keçe	Gövde Malzemesi	Model	Fiyat (USD)
	1/4"	10	0 ~10	Direk Uyarılı	EMC008E2	34,35
	1/4"	10	0,3~10	Pilot Uyarılı	EMC008BE2	34,35
	3/8"	10	0 ~10	Direk Uyarılı	EMC010E2	35,50
	3/8"	10	0,3~10	Pilot Uyarılı	EMC010BE2	35,50
	3/4"	20	0,3~16	Pilot Uyarılı	EMC020BE2	64,05
	1"	20	0 ~10	Direk Uyarılı	EMC025E2	96,55
	36x46x40(EBY)	Ø14,5	-	Yedek Bobin	BOBİN - EMC-DC24V	16,80

Gövde Malzemesi: Pirinç
Keçe Tipi: NBR
Çalışma Sıcaklığı : -5~80°C

EMC Serisi 2/2 Solenoid Valfler (NK)

Fotograf	Ölçü	Orifis (mm)	Keçe	Gövde Malzemesi	Model	Fiyat (USD)
	1/8"	1	0~8	20x25	EMC22001-06AE2	21,35
	1/8"	2	0~25	32x32	EMC22002-06BE2	31,90
	36x46x40(EBY)	Ø12	-	Yedek Bobin	EMC-DC24V-1C	16,80
	36x46x40(EBY)	Ø12	-	Yedek Bobin	EMC-AC220V-1C	16,80



Gövde Malzemesi: Pirinç
Keçe Tipi: NBR
Çalışma Sıcaklığı : -10~80°C

EMC23 Serisi Direk Uyarılı 3/2 Solenoid Valfler (NK)

Fotograf	Ölçü	Orifis (mm)	Keçe	Gövde Malzemesi	Model	Fiyat (USD)
	1/8"	1	0~16	32x32	EMC23001-06BE2	38,40
	1/4"	1	0~16	32x46	EMC23001-08CE2	45,55
	1/8"	2	0~10	32x32	EMC23002-06BE2	38,40
	1/4"	2	0~10	32x46	EMC23002-08CE2	45,55
	36x46x40(EBY)	Ø12	-	Yedek Bobin	EMC-DC24V-1C	16,80
	36x46x40(EBY)	Ø12	-	Yedek Bobin	EMC-AC220V-1C	16,80

Gövde Malzemesi: Pirinç
Keçe Tipi: NBR
Çalışma Sıcaklığı : -10~80°C

UD/UDH Serisi Direk Uyarılı 2/2 Solenoid Valfler (NK)

Fotograf	Ölçü	Orifis (mm)	Keçe	Gövde Malzemesi	Model	Fiyat (USD)
	1/8"	2,5	0~7	Kablolu	UD-06	13,85
	1/4"	4	0~7	Kablolu	UD-08	14,50
	3/8"	4	0~7	Kablolu	UD-10	24,25
	1/8"	1,2	0~20	Kablolu	UDH-06	24,25
	3/8"	2	0~20	Kablolu	UDH-10	13,85

Gövde Malzemesi: Piring
Keçe Tipi: NBR
Çalışma Sıcaklığı : -5~80°C

SLG Serisi Pilot Uyarılı 2/2, Yüksek Sıcaklık, Yüksek Basınç Solenoid Valfler (NK)

Fotograf	Ölçü	Orifis (mm)	Keçe	Gövde Malzemesi	Model	Fiyat (USD)
	3/4"	20	1~40	Soketli	SLG5404E2-20D	117,10
	1"	25	1~40	Soketli	SLG5404E2-25D	125,65
	-	-	Yedek Bobin		BOBİN - SLG - DC24V	17,80
	-	-	Yedek Bobin		BOBİN - SLG - AC220V	17,80
	-	-	Yedek Bobin		BOBİN - SLG - AC24V	17,80

Gövde Malzemesi: Piring
Keçe Tipi: NBR
Çalışma Sıcaklığı : -10~150°C

PUT220 Serisi Pilot Uyarılı 2/2 Solenoid Valfler (NK)

Fotograf	Ölçü	Orifis (mm)	Keçe	Gövde Malzemesi	Model	Fiyat (USD)
	3/8"	8	0~7	Soketli	PUT220E2-03	47,50
	1/2"	13	0~7	Soketli	PUT220E2-04	58,95
	3/4"	20	0~7	Soketli	PUT220E2-06	61,90
	1"	25	0~7	Soketli	PUT220E2-08	96,55
	42mm	Ø14	Yedek Bobin		BOBİN - PU - DC24V	16,80
	Yedek Diyafram				PU220-04-D	3,50
	Yedek Diyafram				PU220-06-D	4,05
	Yedek Diyafram				PU220-08-D	5,25

Gövde Malzemesi: Piring
Keçe Tipi: NBR
Çalışma Sıcaklığı : -5~80°C

ZS Serisi Solenoid Valfler

Fotograf	Ölçü	Orifis (mm)	Keçe	Gövde Malzemesi	Model	Fiyat (USD)
	1/8"	2,5	0 ~ 7	Pirinç	ZS06E2-2.5L	22,20
	1/4"	2,5	0 ~ 7	Pirinç	ZS08E2-2.5L	22,20
	3/8"	10	0 ~ 20	Pirinç	ZS10E2-10L	35,50
	1"	25	0 ~ 10	Pirinç	ZS25E2	78,95
	1"	25	0 ~ 5	Pirinç	ZS25E2H (NA)	97,50
	2"	50	0 ~ 10	Pirinç	ZS50E2	248,30
	Ø20,3x50		Yedek Bobin		BOBİN - ZSC-2D-220VAC	60,20
	Ø20,3x50		Yedek Bobin		BOBİN - ZSC-2D-24VDC	60,20
	Ø20,3x50		Yedek Bobin		BOBİN - ZSC-2D-24VAC	60,20
	Yedek Diyafram				ZS10/15/20-ND - NBR	4,65
	Yedek Diyafram				ZS10/15/20-VD - Viton	9,35
	Yedek Diyafram				ZS25-ND - NBR	5,85
	Yedek Diyafram				ZS25-VD - Viton	14,00
	Yedek Diyafram				ZS35-ND - NBR	8,75
Yedek Diyafram				ZS35-VD - Viton	21,95	
Yedek Diyafram				ZS40ND - NBR	9,35	
Yedek Diyafram				ZS50-ND - NBR	9,35	
Yedek Diyafram				ZS50-VD - Viton	27,80	

EMCF Serisi Patlaç Valf (NK)

Fotograf	Ölçü	Orifis (mm)	Keçe	Gövde Malzemesi	Model	Fiyat (USD)
	2"	50	4 ~ 6	Pirinç	EMCF-50E4	114,70

SLP Serisi Paslanmaz Solenoid Valfler (NK)

Fotograf	Ölçü	Orifis (mm)	Keçe	Gövde Malzemesi	Model	Fiyat (USD)
	1/8"	3	0 ~ 13	SS 316	SLP06E2-3LS1	70,80
	1/4"	3	0 ~ 13	SS 316	SLP08E2-3LS1	70,80

HUS Serisi Paslanmaz Buhar Valfleri NK - PN16 - 250°C

Fotograf	Ölçü	Orifis (mm)	Keçe	Gövde Malzemesi	Model	Fiyat (USD)
	3/8"	15	0,5 ~ 16	SS304	HUS10TE2-10LS2	54,64
	1/2"	15	0,5 ~ 16	SS304	HUS15TE2-15LS2	55,66
	3/4"	20	0,5 ~ 16	SS304	HUS20TE2-20LS2	60,78
	1"	25	0,5 ~ 16	SS304	HUS25TE2-25LS2	70,02

Bağlantı Elemanları - Plastik (Eko Tip / Siyah Kafalı)



Düz Rakor



Döner Dirsek

Kod	Ölçü	Fiyat (USD)
KPC03-M3	3-M3	0,93
KPC03-M5	3-M5	0,93
KPC04-M5	4-M5	0,35
KPC04-M6	4-M6	0,43
KPC04-G01	4-G1/8"	0,46
KPC04-G02	4-G1/4"	0,49
KPC06-M5	6-M5	0,46
KPC06-M6	6-M6	0,50
KPC06-G01	6-G1/8"	0,46
KPC06-G02	6-G1/4"	0,46
KPC06-G03	6-G3/8"	0,95
KPC06-G04	6-G1/2"	1,21
KPC08-G01	8-G1/8"	0,46
KPC08-G02	8-G1/4"	0,45
KPC08-G03	8-G3/8"	0,85
KPC08-G04	8-G1/2"	1,21
KPC10-G01	10-G1/8"	0,82
KPC10-G02	10-G1/4"	0,82
KPC10-G03	10-G3/8"	1,02
KPC10-G04	10-G1/2"	1,21
KPC12-G01	12-G1/8"	1,05
KPC12-G02	12-G1/4"	1,05
KPC12-G03	12-G3/8"	1,10
KPC12-G04	12-G1/2"	1,21
KPC16-G03	16-G3/8"	2,13
KPC16-G04	16-G1/2"	2,13

Kod	Ölçü	Fiyat (USD)
KPL03-M3	3-M3	1,42
KPL03-M5	3-M5	1,42
KPL04-M5	4-M5	0,46
KPL04-M6	4-M6	0,61
KPL04-G01	4-G1/8"	0,50
KPL04-G02	4-G1/4"	0,57
KPL06-M5	6-M5	0,54
KPL06-M6	6-M6	0,68
KPL06-G01	6-G1/8"	0,56
KPL06-G02	6-G1/4"	0,57
KPL06-G03	6-G3/8"	1,05
KPL06-G04	6-G1/2"	1,44
KPL08-G01	8-G1/8"	0,57
KPL08-G02	8-G1/4"	0,61
KPL08-G03	8-G3/8"	1,10
KPL08-G04	8-G1/2"	1,44
KPL10-G01	10-G1/8"	1,00
KPL10-G02	10-G1/4"	1,00
KPL10-G03	10-G3/8"	1,21
KPL10-G04	10-G1/2"	1,44
KPL12-G01	12-G1/8"	1,10
KPL12-G02	12-G1/4"	1,10
KPL12-G03	12-G3/8"	1,26
KPL12-G04	12-G1/2"	1,44
KPL16-G03	16-G3/8"	2,27
KPL16-G04	16-G1/2"	2,27

Bağlantı Elemanları - Plastik (Eko Tip / Siyah Kafalı)



Dişi Rakor

Kod	Ölçü	Fiyat (USD)
KPCF06-G01	6-G1/8"	0,75
KPCF06-G02	6-G1/4"	0,85
KPCF06-G03	6-G3/8"	1,38
KPCF06-G04	6-G1/2"	1,98
KPCF08-G01	8-G1/8"	0,84
KPCF08-G02	8-G1/4"	0,91
KPCF08-G03	8-G3/8"	1,58
KPCF08-G04	8-G1/2"	2,01
KPCF10-G01	10-G1/8"	1,24
KPCF10-G02	10-G1/4"	1,31
KPCF10-G03	10-G3/8"	1,60
KPCF10-G04	10-G1/2"	2,08



Yan Bacak TE

Kod	Ölçü	Fiyat (USD)
KPD06-G01	6-G1/8"	0,77
KPD06-G02	6-G1/4"	0,92
KPD08-G01	8-G1/8"	0,88
KPD08-G02	8-G1/4"	0,92



Orta Bacak TE

Kod	Ölçü	Fiyat (USD)
KPB06-M5	6-M5	0,96
KPB06-G01	6-G1/8"	0,77
KPB06-G02	6-G1/4"	0,92
KPB06-G03	6-G3/8"	1,31
KPB06-G04	6-G1/2"	1,73
KPB08-G01	8-G1/8"	0,88
KPB08-G02	8-G1/4"	0,92
KPB08-G03	8-G3/8"	1,40
KPB08-G04	8-G1/2"	1,73
KPB10-G01	10-G1/8"	1,38
KPB10-G02	10-G1/4"	1,38
KPB10-G03	10-G3/8"	1,69
KPB10-G04	10-G1/2"	1,73
KPB12-G01	12-G1/8"	1,40
KPB12-G02	12-G1/4"	1,40
KPB12-G03	12-G3/8"	1,69
KPB12-G04	12-G1/2"	1,73



Dişi Döner Dirsek

Kod	Ölçü	Fiyat (USD)
KPLF06-G01	6-G1/8"	0,91
KPLF06-G02	6-G1/4"	1,05
KPLF06-G03	6-G3/8"	1,69
KPLF06-G04	6-G1/2"	2,27
KPLF08-G01	8-G1/8"	1,00
KPLF08-G02	8-G1/4"	1,10
KPLF08-G03	8-G3/8"	1,90
KPLF08-G04	8-G1/2"	2,27

Baęlantı Elemanları - Plastik (Eko Tip / Siyah Kafalı)



Hız Ayarlı Döner Dirsek

Kod	Ölçü	Fiyat (USD)
KSC04-M5	4-M5	1,40
KSC04-G01	4-G1/8"	1,65
KSC04-G02	4-G1/4"	2,14
KSC06-M5	6-M5	1,40
KSC06-M6	6-M6	1,40
KSC06-G01	6-G1/8"	1,65
KSC06-G02	6-G1/4"	2,08
KSC06-G03	6-G3/8"	3,15
KSC06-G04	6-G1/2"	4,76
KSC08-G01	8-G1/8"	1,67
KSC08-G02	8-G1/4"	2,19
KSC08-G03	8-G3/8"	3,15
KSC08-G04	8-G1/2"	4,76
KSC10-G01	10-G1/8"	2,57
KSC10-G02	10-G1/4"	2,57
KSC10-G03	10-G3/8"	3,24
KSC10-G04	10-G1/2"	4,76
KSC12-G01	12-G1/8"	2,79
KSC12-G02	12-G1/4"	2,79
KSC12-G03	12-G3/8"	3,33
KSC12-G04	12-G1/2"	4,76



Dirsek

Kod	Ölçü	Fiyat (USD)
KPV04	4 mm	0,31
KPV06	6 mm	0,32
KPV08	8 mm	0,35
KPV10	10 mm	0,50
KPV12	12 mm	0,60
KPV16	16 mm	1,34



Hat Tipi Hız Ayar Valfi

Kod	Ölçü	Fiyat (USD)
KPA04	4 mm	2,37
KPA06	6 mm	2,51
KPA08	8 mm	3,07
KPA10	10 mm	3,35
KPA12	12 mm	5,02



Düz Nipel

Kod	Ölçü	Fiyat (USD)
KPU04	4 mm	0,28
KPU06	6 mm	0,29
KPU08	8 mm	0,31
KPU10	10 mm	0,46
KPU12	12 mm	0,57
KPU16	16 mm	1,33



TE

Kod	Ölçü	Fiyat (USD)
KPE04	4 mm	0,42
KPE06	6 mm	0,43
KPE08	8 mm	0,50
KPE10	10 mm	0,63
KPE12	12 mm	0,78
KPE16	16 mm	1,61

Bağlantı Elemanları - Plastik (Eko Tip / Siyah Kafalı)



YE

Kod	Ölçü	Fiyat (USD)
KPY04	4 mm	0,43
KPY06	6 mm	0,46
KPY08	8 mm	0,56
KPY10	10 mm	0,70
KPY12	12 mm	0,82



Redüksiyon Nipel

Kod	Ölçü	Fiyat (USD)
KPG06-04	6-4	0,33
KPG08-04	8-4	0,39
KPG08-06	8-6	0,39
KPG10-06	10-6	0,54
KPG10-08	10-8	0,54
KPG12-08	12-8	0,67
KPG12-10	12-10	0,67



Redüksiyon YE

Kod	Ölçü	Fiyat (USD)
KPW06-04	6-4-4	0,54
KPW08-06	8-6-6	0,57
KPW10-08	10-8-8	0,74
KPW12-08	12-8-8	0,96
KPW12-10	12-10-10	0,96



Kruva

Kod	Ölçü	Fiyat (USD)
KPZA04	4 mm	0,74
KPZA06	6 mm	0,83
KPZA08	8 mm	0,95
KPZA10	10 mm	1,24
KPZA12	12 mm	1,53
KPZA16	12 mm	4,23



Redüksiyon TE

Kod	Ölçü	Fiyat (USD)
KPEW06-04	4-6-4	0,59
KPEW08-06	6-8-6	0,59
KPEW10-08	8-10-8	0,77
KPEW12-08	8-12-8	0,96
KPEW12-10	10-12-10	0,96



Yükseltici TE

Kod	Ölçü	Fiyat (USD)
KPEG06-04	6-4-6	0,57
KPEG08-06	8-6-8	0,57
KPEG10-08	10-8-10	0,74
KPEG12-08	12-8-12	0,96
KPEG12-10	12-10-12	0,96



Baęlantı Elemanları - Plastik



Düz Rakor

Kod	Ölçü	Fiyat (USD)
EPC03-M3	M3-3 mm	0,95
EPC03-M5	M5-3 mm	0,95
EPC04-M3	M3-4 mm	0,95
EPC04-M5	M5-4 mm	0,47
EPC04-M6	M6-4 mm	0,47
EPC04-G01	1/8"-4 mm	0,50
EPC04-G02	1/4"-4 mm	0,68
EPC04-G03	3/8"-4 mm	1,03
EPC04-G04	1/2"-4 mm	1,83
EPC06-M5	M5-6 mm	0,57
EPC06-M6	M6-6 mm	0,57
EPC06-G01	1/8"-6 mm	0,59
EPC06-G02	1/4"-6 mm	0,72
EPC06-G03	3/8"-6 mm	1,00
EPC06-G04	1/2"-6 mm	1,64
EPC08-G01	1/8"-8 mm	0,68
EPC08-G02	1/4"-8 mm	0,72
EPC08-G03	3/8"-8 mm	1,00
EPC08-G04	1/2"-8 mm	1,73
EPC09-G02	1/4"-9 mm	0,93
EPC10-G01	1/8"-10 mm	1,05
EPC10-G02	1/4"-10 mm	1,10
EPC10-G03	3/8"-10 mm	1,14
EPC10-G04	1/2"-10 mm	1,73
EPC12-G01	1/8"-12 mm	1,38
EPC12-G02	1/4"-12 mm	1,49
EPC12-G03	3/8"-12 mm	1,57
EPC12-G04	1/2"-12 mm	1,78
EPC14-G02	1/4"-14 mm	3,14
EPC14-G03	3/8"-14 mm	3,14
EPC14-G04	1/2"-14 mm	3,27
EPC16-G03	3/8"-16 mm	3,23
EPC16-G04	1/2"-16 mm	3,27



Döner Dirsek

Kod	Ölçü	Fiyat (USD)
EPL03-M3	M3-3 mm	1,45
EPL03-M5	M5-3 mm	1,45
EPL04-M3	M3-4 mm	1,45
EPL04-M5	M5-4 mm	0,68
EPL04-M6	M6-4 mm	0,68
EPL04-G01	1/8"-4 mm	0,71
EPL04-G02	1/4"-4 mm	1,00
EPL06-M5	M5-6 mm	0,74
EPL06-M6	M6-6 mm	0,74
EPL06-G01	1/8"-6 mm	0,86
EPL06-G02	1/4"-6 mm	1,08
EPL06-G03	3/8"-6 mm	1,32
EPL06-G04	1/2"-6 mm	1,90
EPL08-G01	1/8"-8 mm	0,99
EPL08-G02	1/4"-8 mm	1,13
EPL08-G03	3/8"-8 mm	1,39
EPL08-G04	1/2"-8 mm	2,10
EPL09-G02	1/4"-9 mm	1,20
EPL10-G01	1/8"-10 mm	1,58
EPL10-G02	1/4"-10 mm	1,58
EPL10-G03	3/8"-10 mm	1,80
EPL10-G04	1/2"-10 mm	2,50
EPL12-G01	1/8"-12 mm	2,16
EPL12-G02	1/4"-12 mm	2,22
EPL12-G03	3/8"-12 mm	2,45
EPL12-G04	1/2"-12 mm	2,50
EPL14-G02	1/4"-14 mm	4,21
EPL14-G03	3/8"-14 mm	4,30
EPL14-G04	1/2"-14 mm	4,59
EPL16-G02	1/4"-16 mm	4,21
EPL16-G03	3/8"-16 mm	4,30
EPL16-G04	1/2"-16 mm	4,59

Baęlantı Elemanları - Plastik

Diři Rakor

Fotoęraf	Kod	Ölçü	Fiyat (USD)
	EPCF03-M3	M3-3 mm	1,00
	EPCF03-M5	M5-3 mm	1,00
	EPCF04-M3	M3-4 mm	1,00
	EPCF04-M5	M5-4 mm	0,63
	EPCF04-M6	M6-4 mm	0,63
	EPCF04-G01	1/8"-4 mm	0,90
	EPCF04-G02	1/4"-4 mm	1,39
	EPCF04-G03	3/8"-4 mm	1,60
	EPCF04-G04	1/2"-4 mm	2,50
	EPCF06-M5	M5-6 mm	0,92
	EPCF06-G01	1/8"-6 mm	0,90
	EPCF06-G02	1/4"-6 mm	1,14
	EPCF06-G03	3/8"-6 mm	1,60
	EPCF06-G04	1/2"-6 mm	2,20
	EPCF08-G01	1/8"-8 mm	0,96
	EPCF08-G02	1/4"-8 mm	1,23
	EPCF08-G03	3/8"-8 mm	1,75
	EPCF08-G04	1/2"-8 mm	2,20
	EPCF10-G01	1/8"-10 mm	1,47
	EPCF10-G02	1/4"-10 mm	1,52
	EPCF10-G03	3/8"-10 mm	2,00
	EPCF10-G04	1/2"-10 mm	2,34
	EPCF12-G01	1/8"-12 mm	2,00
	EPCF12-G02	1/4"-12 mm	2,33
	EPCF12-G03	3/8"-12 mm	2,46
	EPCF12-G04	1/2"-12 mm	2,59
	EPCF14-G01	1/8"-14 mm	4,00
	EPCF14-G02	1/4"-14 mm	4,00
	EPCF14-G03	3/8"-14 mm	4,32
	EPCF14-G04	1/2"-14 mm	4,54
	EPCF16-G03	3/8"-16 mm	4,32
	EPCF16-G04	1/2"-16 mm	4,54

Bağlantı Elemanları - Plastik

Dişi Döner Dirsek

Fotoğraf	Kod	Ölçü	Fiyat (USD)
	EPLF06-G01	1/8"-6 mm	1,13
	EPLF06-G02	1/4"-6 mm	1,43
	EPLF06-G03	3/8"-6 mm	1,84
	EPLF06-G04	1/2"-6 mm	2,52
	EPLF08-G01	1/8"-8 mm	1,21
	EPLF08-G02	1/4"-8 mm	1,54
	EPLF08-G03	3/8"-8 mm	2,25
	EPLF08-G04	1/2"-8 mm	2,52
	EPLF10-G01	1/8"-10 mm	1,78
	EPLF10-G02	1/4"-10 mm	1,88
	EPLF10-G03	3/8"-10 mm	2,41
	EPLF10-G04	1/2"-10 mm	2,95
	EPLF12-G01	1/8"-12 mm	2,80
	EPLF12-G02	1/4"-12 mm	2,80
	EPLF12-G03	3/8"-12 mm	2,80
	EPLF12-G04	1/2"-12 mm	3,16

Uzun Döner Dirsek

Fotoğraf	Kod	Ölçü	Fiyat (USD)
	EPLL06-G01	1/8"-6 mm	1,20
	EPLL06-G02	1/4"-6 mm	1,57
	EPLL06-G03	3/8"-6 mm	1,74
	EPLL06-G04	1/2"-6 mm	2,61
	EPLL08-G01	1/8"-8 mm	1,44
	EPLL08-G02	1/4"-8 mm	1,64
	EPLL08-G03	3/8"-8 mm	1,88
	EPLL08-G04	1/2"-8 mm	2,89
	EPLL10-G01	1/8"-10 mm	1,94
	EPLL10-G02	1/4"-10 mm	2,06
	EPLL10-G03	3/8"-10 mm	2,42
	EPLL10-G04	1/2"-10 mm	3,34
	EPLL12-G01	1/8"-12 mm	3,27
	EPLL12-G02	1/4"-12 mm	3,50
	EPLL12-G03	3/8"-12 mm	3,60
	EPLL12-G04	1/2"-12 mm	3,78

Bağlantı Elemanları – Plastik



Orta Bacak Tee

Kod	Ölçü	Fiyat (USD)
EPB03-M3	M3-3 mm	1,84
EPB03-M5	M5-3 mm	1,84
EPB04-M3	M3-4 mm	1,84
EPB04-M5	M5-4 mm	0,98
EPB04-M6	M6-4 mm	0,98
EPB04-G01	1/8"-4 mm	0,99
EPB04-G02	1/4"-4 mm	1,35
EPB04-G03	3/8"-4 mm	1,84
EPB04-G04	1/2"-4 mm	2,30
EPB06-M5	M5-6 mm	1,04
EPB06-G01	1/8"-6 mm	1,04
EPB06-G02	1/4"-6 mm	1,35
EPB06-G03	3/8"-6 mm	1,62
EPB06-G04	1/2"-6 mm	2,30
EPB08-G01	1/8"-8 mm	1,24
EPB08-G02	1/4"-8 mm	1,47
EPB08-G03	3/8"-8 mm	1,73
EPB08-G04	1/2"-8 mm	2,57
EPB10-G01	1/8"-10 mm	1,85
EPB10-G02	1/4"-10 mm	1,90
EPB10-G03	3/8"-10 mm	2,12
EPB10-G04	1/2"-10 mm	2,57
EPB12-G01	1/8"-12 mm	2,42
EPB12-G02	1/4"-12 mm	2,65
EPB12-G03	3/8"-12 mm	2,65
EPB12-G04	1/2"-12 mm	2,85
EPB14-G03	3/8"-14 mm	4,30
EPB14-G04	1/2"-14 mm	4,59
EPB15-G03	3/8"-15 mm	4,30
EPB15-G04	1/2"-15 mm	4,59
EPB16-G03	3/8"-16 mm	NET FİYAT 1,50
EPB16-G04	1/2"-16 mm	5,33



Yan Bacak Tee

Kod	Ölçü	Fiyat (USD)
EPD08-G02	1/4"-8 mm	1,47
EPD08-G03	3/8"-8 mm	1,73
EPD08-G04	1/2"-8 mm	2,57
EPD10-G01	1/8"-10 mm	0,60
EPD10-G02	1/4"-10 mm	0,62
EPD10-G03	3/8"-10 mm	0,69
EPD10-G04	1/2"-10 mm	0,83
EPD12-G01	1/8"-12 mm	2,42
EPD12-G02	1/4"-12 mm	0,86
EPD12-G03	3/8"-12 mm	0,86
EPD12-G04	1/2"-12 mm	0,92
EPD14-G03	3/8"-14 mm	4,30
EPD14-G04	1/2"-14 mm	4,59

NET FİYAT

Baęlantı Elemanları - Plastik



Orta Bacak Yee

Kod	Ölçü	Fiyat (USD)
EPWT04-M3	M3-4 mm	1,84
EPWT04-M5	M5-4 mm	0,98
EPWT04-G01	1/8"-4 mm	1,08
EPWT04-G02	1/4"-4 mm	1,34
EPWT06-M5	M5-6 mm	1,14
EPWT06-G01	1/8"-6 mm	1,30
EPWT06-G02	1/4"-6 mm	1,35
EPWT06-G03	3/8"-6 mm	1,68
EPWT06-G04	1/2"-6 mm	2,30
EPWT08-G01	1/8"-8 mm	1,45
EPWT08-G02	1/4"-8 mm	1,47
EPWT08-G03	3/8"-8 mm	1,90
EPWT08-G04	1/2"-8 mm	2,57
EPWT10-G01	1/8"-10 mm	1,85
EPWT10-G02	1/4"-10 mm	1,98
EPWT10-G03	3/8"-10 mm	2,18
EPWT10-G04	1/2"-10 mm	2,57
EPWT12-G02	1/4"-12 mm	2,65
EPWT12-G03	3/8"-12 mm	2,65
EPWT12-G04	1/2"-12 mm	2,85
EPWT14-G01	1/8"-14 mm	4,30
EPWT14-G02	1/4"-14 mm	4,30
EPWT14-G03	3/8"-14 mm	4,30
EPWT14-G04	1/2"-14 mm	4,59
EPWT16-G03	3/8"-16 mm	4,63
EPWT16-G04	1/2"-16 mm	5,33



Açık Döner Dirsek

Kod	Ölçü	Fiyat (USD)
EPHF04-G01	1/8"-4 mm	1,76
EPHF04-G02	1/4"-4 mm	1,76
EPHF06-M6	M6-6 mm	1,24
EPHF06-G01	1/8"-6 mm	1,76
EPHF06-G02	1/4"-6 mm	1,76
EPHF06-G03	3/8"-6 mm	2,10
EPHF06-G04	1/2"-6 mm	3,20
EPHF08-G01	1/8"-8 mm	1,41
EPHF08-G02	1/4"-8 mm	1,76
EPHF08-G03	3/8"-8 mm	2,18
EPHF08-G04	1/2"-8 mm	3,28
EPHF10-G02	1/4"-10 mm	2,03
EPHF10-G03	3/8"-10 mm	2,36
EPHF10-G04	1/2"-10 mm	3,42
EPHF12-G02	1/4"-12 mm	2,11
EPHF12-G03	3/8"-12 mm	2,38
EPHF12-G04	1/2"-12 mm	3,48

Bağlantı Elemanları – Plastik



EPKB-EPKD Çoklu Dağıtıcı

Kod	Ölçü	Fiyat (USD)
EPKB04-G01	1/8"-4x4 mm	2,27
EPKB04-G02	1/4"-4x4 mm	2,56
EPKB06-G01	1/8"-4x6 mm	2,27
EPKB06-G02	1/4"-4x6 mm	2,56
EPKB06-G03	3/8"-4x6 mm	2,70
EPKB08-G01	1/8"-4x8 mm	2,70
EPKB08-G02	1/4"-4x8 mm	2,85
EPKB08-G03	3/8"-4x8 mm	2,90
EPKD0604-G01	1/8"- 6-4-4-4	2,84
EPKD08-04-G02	1/4"- 8-4-4-4	2,87
EPKD08-06-G02	1/4"- 8-6-6-6	3,15



EHVFS Küresel Vana

Kod	Ölçü	Fiyat (USD)
EHVFS06-G01	1/8"-6 mm	1,23
EHVFS06-G02	1/4"-6 mm	1,23
EHVFS06-G03	3/8"-6 mm	1,43
EHVFS06-G04	1/2"-6 mm	1,52
EHVFS08-G01	1/8"-8 mm	1,30
EHVFS08-G02	1/4"-8 mm	1,36
EHVFS08-G03	3/8"-8 mm	1,49
EHVFS08-G04	1/2"-8 mm	1,60
EHVFS10-G01	1/8"-10 mm	1,36
EHVFS10-G02	1/4"-10 mm	1,43
EHVFS10-G03	3/8"-10 mm	1,57
EHVFS10-G04	1/2"-10 mm	1,68

NET FİYAT

Bağlantı Elemanları – Plastik



ESC - Hız Ayarlı Döner Dirsek

Kod	Ölçü	Fiyat (USD)
ESC04-M5	M5-4 mm	2,24
ESC04-G01	1/8"-4 mm	2,57
ESC04-G02	1/4"-4 mm	2,83
ESC06-M5	M5-6 mm	2,48
ESC06-M6	M6-6	2,48
ESC06-G01	1/8"-6 mm	2,48
ESC06-G02	1/4"-6 mm	2,82
ESC06-G03	3/8"-6 mm	4,59
ESC06-G04	1/2"-6 mm	6,10
ESC08-G01	1/8"-8 mm	2,52
ESC08-G02	1/4"-8 mm	2,89
ESC08-G03	3/8"-8 mm	4,63
ESC08-G04	1/2"-8 mm	6,20
ESC10-G01	1/8"-10 mm	2,95
ESC10-G02	1/4"-10 mm	3,10
ESC10-G03	3/8"-10 mm	4,79
ESC10-G04	1/2"-10 mm	6,91
ESC12-G01	1/8"-12 mm	3,10
ESC12-G02	1/4"-12 mm	3,39
ESC12-G03	3/8"-12 mm	4,95
ESC12-G04	1/2"-12 mm	6,96
ESC16-G03	3/8"-16 mm	8,00
ESC16-G04	1/2"-16 mm	8,00

Bağlantı Elemanları – Plastik



EHVFF Küresel Vana

Kod	Ölçü	Fiyat (USD)
EHVFF04-04	4 mm	4,06
EHVFF06-06	6 mm	4,30
EHVFF08-08	8 mm	4,50
EHVFF10-10	10 mm	6,00
EHVFF12-12	12 mm	8,20



EPK Çoklu Dağıtıcı

Kod	Ölçü	Fiyat (USD)
EPK04	5x4 mm	1,55
EPK06	5x6 mm	1,76
EPK08	5x8 mm	2,00



EPA - Hız Ayar Valfi

Kod	Ölçü	Fiyat (USD)
ESA(EPA)04	4 mm	2,80
ESA(EPA)06	6 mm	3,00
ESA(EPA)08	8 mm	3,50
ESA(EPA)10	10 mm	4,35
ESA(EPA)12	12 mm	6,45



EPKG - Redüksiyon Kollektör

Kod	Ölçü	Fiyat (USD)
EPKG10-06	10-6-6-6-10	2,42

EPZA - Kruva

Fotograf	Kod	Ölçü	Fiyat (USD)
	EPZA04	4 mm	0,88
	EPZA06	6 mm	0,98
	EPZA08	8 mm	1,10
	EPZA10	10 mm	1,50
	EPZA12	12 mm	1,80

EPP - Tapa

Fotograf	Kod	Ölçü	Fiyat (USD)
	EPP04	4 mm	0,32
	EPP06	6 mm	0,40
	EPP08	8 mm	0,44
	EPP10	10 mm	0,55
	EPP12	12 mm	0,69

Bağlantı Elemanları – Plastik

EPU - Nipel

Fotograf	Kod	Ölçü	Fiyat (USD)
	EPU04	4 mm	0,37
	EPU05	5 mm	0,55
	EPU06	6 mm	0,41
	EPU07	7 mm	0,55
	EPU08	8 mm	0,46
	EPU09	9 mm	0,75
	EPU10	10 mm	0,62
	EPU11	11 mm	1,00
	EPU12	12 mm	0,81
	EPU14	14 mm	2,00
	EPU15	15 mm	2,00
	EPU16	16 mm	2,00
	EPU3/8	3/8"	1,08
	EPU1/2	1/2"	1,36

EPE - Tee

Fotograf	Kod	Ölçü	Fiyat (USD)
	EPE04	4 mm	0,51
	EPE06	6 mm	0,60
	EPE07	7 mm	0,62
	EPE08	8 mm	0,62
	EPE09	9 mm	1,18
	EPE10	10 mm	0,90
	EPE12	12 mm	1,10
	EPE14	14 mm	2,48
	EPE15	15 mm	2,48
	EPE16	16 mm	2,48

EPV - Dirsek

Fotograf	Kod	Ölçü	Fiyat (USD)
	EPV04	4 mm	0,37
	EPV06	6 mm	0,41
	EPV08	8 mm	0,46
	EPV10	10 mm	0,62
	EPV12	12 mm	0,81
	EPV14	14 mm	NET FİYAT 0,73
	EPV16	16 mm	2,25

EPY - Yee

Fotograf	Kod	Ölçü	Fiyat (USD)
	EPY04	4 mm	0,51
	EPY06	6 mm	0,60
	EPY08	8 mm	0,65
	EPY10	10 mm	1,00
	EPY12	12 mm	1,15
	EPY14	14 mm	NET FİYAT 0,78
	EPY16	16 mm	2,40

Bağlantı Elemanları – Plastik

EPEG - Yükseltici Tee

Fotograf	Kod	Ölçü	Fiyat (USD)
	EPEG06-04	6-4-6	0,65
	EPEG08-04	8-4-8	0,71
	EPEG08-06	8-6-8	0,71
	EPEG10-06	10-6-10	0,90
	EPEG10-08	10-8-10	0,90
	EPEG12-08	12-8-12	1,33
	EPEG12-10	12-10-12	1,33
	EPEG14-12	14-12-14	2,92
	EPEG16-12	16-12-16	3,50

EPEW - Redüksiyon Tee

Fotograf	Kod	Ölçü	Fiyat (USD)
	EPEW06-04	4-6-4	0,73
	EPEW08-04	4-8-4	0,73
	EPEW08-06	6-8-6	0,73
	EPEW10-06	6-10-6	1,05
	EPEW10-08	8-10-8	1,05
	EPEW12-08	8-12-8	1,47
	EPEW12-10	10-12-10	1,47

EPG - Redüksiyon Nipel

Fotograf	Kod	Ölçü	Fiyat (USD)
	EPG06-04	6-4	0,46
	EPG08-04	8-4	0,59
	EPG08-06	8-6	0,59
	EPG09-08	9-8	0,81
	EPG10-06	10-6	0,64
	EPG10-08	10-8	0,64
	EPG12-06	12-6	0,91
	EPG12-08	12-8	0,91
	EPG12-10	12-10	0,91
	EPG14-12	14-12	2,42
	EPG16-12	16-12	2,44

EPW - Redüksiyon Yee

Fotograf	Kod	Ölçü	Fiyat (USD)
	EPW06-04	6-4-4	0,64
	EPW08-06	8-6-6	0,70
	EPW10-08	10-8-8	0,90
	EPW12-10	12-10-10	1,33

EPM - Perde Geçiş Nipel

Fotograf	Kod	Ölçü	Fiyat (USD)
	EPM04	4 mm	1,20
	EPM06	6 mm	1,48
	EPM08	8 mm	1,74
	EPM10	10 mm	2,87
	EPM12	12 mm	3,50
	EPM14	14 mm	4,87
	EPM16	16 mm	5,19

EPGJ - Borulu Redüksiyon

Fotograf	Kod	Ölçü	Fiyat (USD)
	EPGJ06-04	6-4	0,63
	EPGJ08-06	8-6	0,68
	EPGJ10-08	10-8	0,79
	EPGJ12-08	12-8	0,99
	EPGJ12-10	12-10	1,03

Pnömatik Bağlantı Elemanları - Plastik, Metrik Dişli

EPC - Düz Rakor

Fotograf	Kod	Ölçü	Fiyat (USD)
	EPC06-10	08-M10*1,5	0,78
	EPC06-12	06-M12*1,5	0,78
	EPC06-14	06-M14*1,5	0,90
	EPC06-16	06-M16*1,5	1,10
	EPC06-18	06-M18*1,5	1,22
	EPC06-22	06-M22*1,5	1,70
	EPC08-10	08-M10*1,5	0,80
	EPC08-12	08-M12*1,5	0,80
	EPC08-14	08-M14*1,5	0,94
	EPC08-16	08-M16*1,5	1,10
	EPC08-18	08-M18*1,5	1,60
	EPC08-22	08-M22*1,5	1,90
	EPC10-10	10-M10*1,5	1,20
	EPC10-12	10-M12*1,5	1,20
	EPC10-14	10-M14*1,5	1,20
	EPC10-16	10-M16*1,5	1,30
	EPC10-18	10-M18*1,5	1,66
	EPC10-22	10-M22*1,5	1,90
	EPC12-12	12-M12*1,5	1,70
	EPC12-14	12-M14*1,5	1,70
	EPC12-16	12-M16*1,5	1,80
	EPC12-18	12-M18*1,5	1,87
	EPC12-22	12-M22*1,5	2,15

EPL - Döner Dirsek

Fotograf	Kod	Ölçü	Fiyat (USD)
	EPL06-12	06-M12*1,5	1,18
	EPL06-14	06-M14*1,5	1,20
	EPL06-16	06-M16*1,5	1,40
	EPL06-18	06-M18*1,5	2,31
	EPL06-22	06-M22*1,5	3,30
	EPL08-12	08-M12*1,5	1,25
	EPL08-14	08-M14*1,5	1,30
	EPL08-16	08-M16*1,5	1,50
	EPL08-18	08-M18*1,5	2,34
	EPL08-22	08-M22*1,5	2,40
	EPL10-12	10-M12*1,5	1,70
	EPL10-14	10-M14*1,5	1,80
	EPL10-16	10-M16*1,5	2,03
	EPL10-18	10-M18*1,5	2,40
	EPL10-22	10-M22*1,5	2,80
	EPL12-12	12-M12*1,5	2,40
	EPL12-14	12-M14*1,5	2,50
	EPL12-16	12-M16*1,5	2,65
	EPL12-18	12-M18*1,5	2,70
	EPL12-22	12-M22*1,5	2,80

Pnömatik Bağlantı Elemanları - Plastik, Metrik Dişli

EPB- Orta Bacak Tee

Fotograf	Kod	Ölçü	Fiyat (USD)
	EPB06-12	06-M12*1,5	1,41
	EPB06-16	06-M16*1,5	1,78
	EPB08-12	08-M12*1,5	1,65
	EPB08-16	08-M16*1,5	2,02
	EPB08-22	08-M22*1,5	2,80
	EPB10-12	10-M12*1,5	2,19
	EPB10-16	10-M16*1,5	2,29
	EPB10-22	10-M22*1,5	3,02
	EPB12-16	12-M16*1,5	3,12
	EPB12-22	12-M22*1,5	3,28

EPD - Yan Bacak Tee

Fotograf	Kod	Ölçü	Fiyat (USD)
	EPD06-12	06-M12*1,5	1,41
	EPD06-16	06-M16*1,5	1,78
	EPD08-12	08-M12*1,5	1,65
	EPD08-16	08-M16*1,5	2,02
	EPD08-22	08-M22*1,5	2,80
	EPD10-12	10-M12*1,5	2,19
	EPD10-16	10-M16*1,5	2,29
	EPD10-22	10-M22*1,5	3,02
	EPD12-16	12-M16*1,5	3,12
	EPD12-22	12-M22*1,5	3,28

TEFLONLU Yan Bacak Tee

Fotograf	Kod	Ölçü	Fiyat (USD)
	EPD06-02	1/4"-6 mm	1,35
	EPD06-03	3/8"-6 mm	1,68
	EPD08-01	1/8"-8 mm	1,24
	EPD08-02	1/4"-8 mm	1,47
	EPD08-03	3/8"-8 mm	1,73
	EPD08-04	1/2"-8 mm	2,57
	EPD10-01	1/8"-10 mm	1,85
	EPD10-02	1/4"-10 mm	1,90
	EPD10-03	3/8"-10 mm	2,12
	EPD10-04	1/2"-10 mm	2,57
	EPD12-02	1/4"-12 mm	2,65
	EPD12-04	1/2"-12 mm	2,85

TEFLONLU Orta Bacak Tee

Fotograf	Kod	Ölçü	Fiyat (USD)
	EPB04-01	1/8"-4 mm	0,99
	EPB04-02	1/4"-4 mm	1,35
	EPB06-01	1/8"-6 mm	1,04
	EPB06-03	3/8"-6 mm	1,62
	EPB06-04	1/2"-6 mm	2,30
	EPB08-03	3/8"-8 mm	1,73
	EPB08-04	1/2"-8 mm	2,57
	EPB10-01	1/8"-10 mm	1,85
	EPB12-03	3/8"-12 mm	2,65
	EPB12-04	1/2"-12 mm	2,85

Pnömatik Susturucular

A - Sinter Bronz Susturucu / Uzun Tip

Fotograf	Kod	Ölçü	Fiyat (USD)
	A-M5	M5	0,39
	A-06	1/8"	0,43
	A-08	1/4"	0,75
	A-10	3/8"	1,23
	A-15	1/2"	1,77
	A-20	3/4"	3,71
	A-25	1"	6,31
	A-32	1 1/4"	25,35
	A-40	1 1/2"	29,48
	A-50	2"	37,14

V - Sinter Bronz Susturucu / Kısa Tip

Fotograf	Kod	Ölçü	Fiyat (USD)
	V-M5	M5	0,35
	V-06	1/8"	0,38
	V-08	1/4"	0,59
	V-10	3/8"	0,82
	V-15	1/2"	1,10
	V-20	3/4"	2,33
	V-25	1"	3,95

SD - Sinter Bronz Susturucu / Kısmalı Tip

Fotograf	Kod	Ölçü	Fiyat (USD)
	SD-06	1/8"	1,30
	SD-08	1/4"	1,74
	SD-10	3/8"	2,61
	SD-15	1/2"	5,13
	SD-20	3/4"	10,02
	SD-25	1"	17,69

SU - Plastik Susturucu

Fotograf	Kod	Ölçü	Fiyat (USD)
	SU-06	1/8"	0,38
	SU-08	1/4"	0,44
	SU-10	3/8"	0,57
	SU-15	1/2"	0,66
	SU-20	3/4"	4,98
	SU-25	1"	5,90

PNSL - UZUN SUSTURUCU

Fotograf	Kod	Ölçü	Fiyat (USD)
	PNSL-01	1/8"	0,38
	PNSL-02	1/4"	0,68
	PNSL-03	3/8"	1,07
	PNSL-04	1/2"	1,65











POH - SETSKUR KÖR TAPA

Fotograf	Kod	Ölçü	Fiyat (USD)
	POH-01	1/8"	0,39
	POH-02	1/4"	0,50
	POH-03	3/8"	0,91
	POH-04	1/2"	1,40





POR - ALLEN BAŞLI KÖR TAPA





Fotograf	Kod	Ölçü	Fiyat (USD)
	POR-01	1/8"	0,50
	POR-02	1/4"	0,81
	POR-03	3/8"	1,24
	POR-04	1/2"	1,90

Pnömatik Bağlantı Elemanları - Metal







ÖLÇÜ	EMPC Düz Rakor	EMPL Döner Dirsek	EMPCF Dişi Rakor	EMPB Orta Bacak "T"	EMPD Yan Bacak "T"	EMPC Hız Ayarlı Döner Dirsek
						
04-M5	0,87	1,99	1,60	2,29	2,29	4,19
04-1/8"	1,05	1,99	1,60	2,44	2,44	5,47
04-1/4"	1,39		1,60	2,59	2,59	6,78
04-3/8"	1,96	2,79	2,20	4,12	4,12	11,69
04-1/2"	2,10	3,34	2,75	4,80	-	15,92
06-M5	1,13	2,64	1,60	2,55	2,55	4,19
06-1/8"	1,14	2,16	1,75	3,52	3,52	5,47
06-1/4"	1,40	2,28	1,90	3,52	3,52	7,42
06-3/8"	1,96	2,79	2,40	4,20	4,20	11,69
06-1/2"	2,68	3,52	3,00	5,02	5,02	15,92
08-1/8"	1,29	2,89	1,80	4,72	4,72	5,47
08-1/4"	1,63	2,90	2,10	4,72	4,72	7,42
08-3/8"	2,02	3,11	2,60	4,91	4,91	11,69
08-1/2"	2,79	3,70	3,20	5,57	5,57	15,92
10-1/8"	2,01	3,32	2,20	3,99	3,99	10,33
10-1/4"	2,01	3,32	2,30	4,72	4,72	10,33
10-3/8"	2,32	3,66	2,80	4,91	4,91	11,69
10-1/2"	2,96	4,13	3,55	5,57	5,57	15,92
12-1/8"		-	-	-	-	15,35
12-1/4"	2,36	4,68	2,67	6,63	6,63	14,65
12-3/8"	2,78	4,68	3,41	6,78	6,78	15,35
12-1/2"	3,28	4,92	3,75	7,23	7,23	18,28
14-3/8"	5,32	6,82	-	-	-	-
14-1/2"	6,04	7,97	-	-	-	-
16-3/8"	5,48	7,51	-	-	-	-
16-1/2"	6,04	8,59	-	-	-	-
Ölçü Ø mm	EMPU Düz Nipel	EMPV Dirsek	EMPE "T"	EMPY "Y"	EMPM Perde Geçiş Nipeli	
						
4	1,28	2,00	2,34	2,69	2,80	
6	1,56	2,00	2,98	3,10	2,90	
8	2,05	2,19	3,60	4,88	3,71	
10	2,77	3,24	5,76	6,42	4,39	
12	3,29	3,47	6,07	8,01	5,11	
14	6,45	5,79	-	-	-	
16	7,26	6,45	-	-	-	

Pnömatik Bağlantı Elemanları - Somun Sıkmalı

ÖLÇÜ	RPC Düz Rakor	RPL Döner Dirsek	RPT Orta Bacak "T"	RPD Yan Bacak "T"	MNSR "Hız Ayarlı Döner Dirsek"
					
4/2-1/8"	0,86	1,87	-	-	-
6/4-M5	0,93	1,76	-	-	-
6/4-1/8"	0,93	1,96	3,19	3,19	6,80
6/4-1/4"	1,21	1,96	3,27	3,27	8,51
6/4-3/8"	1,42	2,22	3,50	3,50	8,96
6/4-1/2"	2,62	2,93	-	-	10,00
8/6-1/8"	1,26	2,42	3,19	3,19	6,80
8/6-1/4"	1,40	2,42	4,05	4,05	8,65
8/6-3/8"	1,80	2,47	4,05	4,05	13,12
8/6-1/2"	2,62	3,16	4,50	4,50	17,44
10/8-1/8"	1,53	3,29	-	-	-
10/8-1/4"	1,53	3,33	-	-	-
10/8-3/8"	1,97	3,48	-	-	-
10/8-1/2"	3,03	3,50	-	-	-
12/10-1/4"	2,34	4,53	-	-	-
12/10-3/8"	2,55	4,98	-	-	-
12/10-1/2"	3,47	5,22	-	-	-

ÖLÇÜ	RPUC Düz Nipel	RPUL Dirsek	RPUT "T"	RPZA Kruva
				
4/2	1,33	-	2,19	-
6/4	1,33	1,86	2,19	3,77
8/6	1,91	2,02	2,93	5,95
10/8	2,64	-	3,52	-
12/9	3,77	-	-	-
12/10	3,77	-	6,20	-

Hava Tabancaları

Fotograf	Tanım	Renk Seçenekleri	Model	Fiyat (USD)
	Plastik Hava Tabancası	Kırmızı, Mavi, Siyah	EB-094	2,09
	Plastik Hava Tabancası Uzun Tip (30cm)	Kırmızı	A300	3,98
	Metal Hava Tabancası (Jaklı)	Metalik Gri	EB-092	5,72
	Metal Hava Tabancası (1/4" BSP)	Metalik Gri	EB-092A	5,25
	Metal Hava Tabancası (Jaklı - Uzun)	Metalik Gri	EB-093	6,56
	Metal Hava Tabancası Uzun Tip (1/4" BSP - 30cm)	Metalik Gri	DG-10B-3	6,90

Hortum Makası ve Pnömatik Makas

Hortum Makası

Fotograf	Kod	Fiyat (USD)
	TC-B	3,28

Pnömatik Makas

Fotograf	Kod	Fiyat (USD)
	MPM-30	200,00

Hidropnömatik ve Elektrikli Silindirler

Fotograf	Kod	Fiyat (USD)	
	Hidropnömatik Silindir	PHD-D-63X150-15F	603,00
		PHD-D-80X150-5F	723,00
	Servo Motor+Sürücü+Kablo	ELH080H07*1* + ELHS18-E07A	394,31
		ELH080H10*1* + ELHS18-E10A	412,13
		ELH130H15*1* + ELHS18-E15A	480,49
		ELH130H20*1* + ELHS28-E20A	514,19
	Elektrikli Silindir+Kaplin	EGE-25-400-SP-KF	729,65
		EGE-25-400-ZR-KF-LN-RB	595,19
		EGE-40-400-SP-KF	1.029,35
		EGE-40-400-ZR-KF-LN-RB	875,12

NET FİYAT

Pirinç Kruva ve Hava Jakları

EMBCR - Pirinç Hortum Kruva

Fotograf	Kod	Ölçü	Fiyat (USD)
	EMBCR	6mm	1,28
		8mm	1,56
		10mm	2,28
		12mm	2,84
		16mm	4,98

NET FİYAT

Hava Jakı

Fotograf	Kod	Ölçü	Fiyat (USD)
	FQ-EU-12	1/2"	1,22

PNÖMATİK

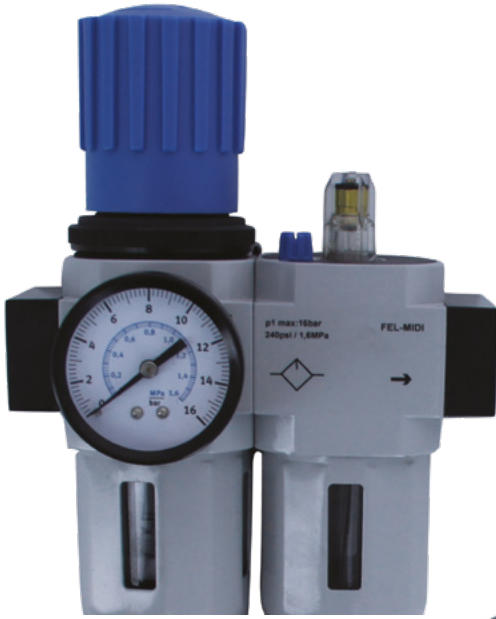

PNÖMATİK HORTUMLAR



FIRETECH ***GAPEX***[®]

Kimyasal Dayanım Cetveli

Chemical Resistance Table

	PA	PE	PVC	PUR		PA	PE	PVC	PUR		
	Polyamide	Polyethylene	Polyvinyl chloride soft	Polyurethane		Polyamide	Polyethylene	Polyvinyl chloride soft	Polyurethane		
1	Acetic acid	4	2	3	3	100	Lemon juice	1	1	1	1
2	Acetic acid anhydride	1	3	4	4	101	Linseed oil	1	1	3	1
3	Acetone	1	1	5	4	102	Liquors	1	1	2	1
4	Aluminium salts, aq	1	4	1	2	103	Magnesium salts, aq	1	1	1	1
5	Alums, aq	1	1	1	1	104	Margarine	1	3	1	1
6	Aminobenzoic acid	2	1	3	4	105	Mercury	1	1	3	1
7	Ammonia, aq	1	1	4	4	106	Mercury salts, aq	1	1	3	1
8	Ammonia, g	1	1	1	1	107	Methanol	1	1	3	2
9	Ammonium acetate, aq	1	1	1	4	108	Methyl ethyl ketone	1	4	3	4
10	Ammonium carbonate, aq	1	1	1	4	109	Methylene chloride	3	4	4	4
11	Ammonium chloride, aq	1	1	1	1	110	Milk	1	1	1	1
12	Ammonium nitrate, aq	1	1	1	1	111	Mustard	1	1	1	1
13	Ammonium phosphate, aq	1	1	1	1	112	Nail varnish	1	1	4	4
14	Ammonium sulfate, aq	1	1	1	1	113	Nail varnish remover	1	1	4	4
15	Amylalcohol	1	1	1	2	114	Naphthalin	1	4	2	1
16	Antifreeze	1	1	1	2	115	Nickel salts, aq	1	1	1	1
17	Barrium salts	1	1	1	1	116	Nitric acid (up to 25 %)	4	2	1	5
18	Battery acid	3	1	3	1	117	Nitrobenzoic acid	2	4	4	4
19	Beef tallow	3	1	2	1	118	Octane	1	1	4	1
20	Beer	1	1	1	1	119	Oil no. 3 (ASTM D390-59)	1	3	2	1
21	Benzaldehyde	1	1	3	3	120	Oleic acid	2	2	2	1
22	Benzoic acid	1	1	3	4	121	Olive oil	1	1	2	1
23	Benzoic acid, aq	1	1	1	4	122	Oxalic acid, aq	2	1	3	4
24	Bone fat	1	2	3	1	123	Ozone (<0.5 ppm)	1	4	3	1
25	Boric acid	1	1	1	1	124	Palm oil	1	4	3	2
26	Brake fluid	1	3	3	4	125	Paraffin	1	3	1	2
27	Bromine, aq	4	4	4	4	126	Paraffin ether	1	4	3	1
28	Bromine, l	4	4	4	4	127	Paraffin oil	1	3	1	2
29	Butane, g	1	4	1	1	128	Paraffin oil (petroleum jelly)	1	3	2	2
30	Butane, l	1	1	2	1	129	Pectin	1	1	1	1
31	n-Butanol	1	4	3	4	130	Pepper	1	1	1	1
32	n-Butyl alcohol	1	4	4	4	131	Peppermint oil	1	3	2	1
33	Butylacetate (acetic acid butyl ester)	4	4	5	4	132	Perfume	1	1	4	1
34	Butylacetate	1	2	4	4	133	Phenol	4	4	4	4
35	Calcium chloride, aq	1	1	1	1	134	Phosphone acid	4	4	1	3
36	Calcium nitrate, aq	1	1	1	1	135	Phosphorus pentoxide	3	1	1	2
37	Carbon disulfide	1	4	4	3	136	Pine needle oil	1	2	2	2
38	Carbon tetrachloride	1	4	4	3	137	Potassium carbonate	1	1	1	3
39	Carnation oil	1	4	2	1	138	Potassium chlorate, aq	2	1	1	2
40	Chlorine, g	4	4	4	4	139	Potassium chloride, aq	1	1	1	1
41	Chlorine, l	4	4	4	4	140	Potassium chromate, aq	3	1	1	1
42	Chlorobenzoic acid	3	4	4	3	141	Potassium hydroxide, aq	1	1	2	1
43	Chloroform	3	4	4	4	142	Potassium iodine, aq	1	1	1	2
44	Chlorosulfonic acid	4	4	4	4	143	Potassium nitrate, aq	1	1	1	2
45	Chrome bath	4	1	1	3	144	Potassium permanganese, aq	3	1	1	3
46	Chromic acid	4	2	3	4	145	Potassium sulfate	1	1	1	1
47	Chromosulfuric acid	4	1	2	3	146	Propane, g	1	3	1	2
48	Chromium salts	4	1	1	3	147	Propane, l	1	4	1	2
49	Citric acid	1	1	1	2	148	Pyridine	1	1	4	5
50	Cleaner	1	1	1	1	149	Rum	1	1	2	1
51	Coca-Cola	1	1	1	1	150	Sea water	1	1	1	1
52	Cocua	1	1	1	1	151	Shampoo	1	1	1	1
53	Coconut oil	1	2	1	1	152	Silicon oil	1	1	4	1
54	Cod-liver	1	1	4	1	153	Silver salts, aq	1	1	1	1
55	Coffee	1	1	1	1	154	Soapy water	1	1	1	2
56	Cooking oil, animal	1	3	2	2	155	Soda	1	1	1	1
57	Cooking oil, vegetable	1	4	2	2	156	Sodium bicarbonate, aq	1	1	1	1
58	Corn oil	1	4	1	2	157	Sodium bisulfite, aq	1	1	1	2
59	Cresol	4	4	4	4	158	Sodium carbonate (borax), aq	1	1	1	1
60	Cresol, aq	3	4	4	4	159	Sodium carbonate, aq	1	1	1	1
61	Cyclohexane	1	1	1	2	160	Sodium chlorate	2	1	1	2
62	Cyclohexanol	1	1	5	4	161	Sodium chloride, aq	1	1	1	1
63	Cyclohexanone	1	4	5	1	162	Sodium hydroxide (caustic soda)	1	4	4	4
64	Decalin	1	1	1	2	163	Sodium hydroxide, aq	1	1	1	2
65	Detergent	1	1	2	1	164	Sodium hypochlorite	3	1	3	4
66	Dibutyl phtalate	1	3	3	3	165	Sodium nitrate, aq	1	1	1	1
67	Diesel fuel	1	2	2	1	166	sodium nitrite, aq	2	1	1	1
68	Dimethylether	1	2	2	2	167	Sodium perborate, aq	1	1	3	2
69	Dimethylformamide	1	1	4	4	168	Sodium phosphate, aq	1	1	1	2
70	1,4-Dicxane	1	1	4	4	169	Sodium silicate	1	1	1	3
71	Engine oil	1	3	3	2	170	Sodium sulfate, aq	1	1	1	1
72	Ethanol	1	1	3	1	171	Sodium sulfide, aq	1	1	1	1
73	Ether	1	4	3	3	172	Sodium sulfite, aq	1	1	1	1
74	Ethyl acetate	1	2	5	4	173	Sodium thiosulfate	1	1	1	2
75	Ethylene chloride	3	4	4	2	174	Sodium thiosulfate (antichlor),aq	1	1	1	2
76	Ethylhexanol	1	4	4	4	175	Soybean oil	1	4	2	2
77	Ferric salts	1	1	1	2	176	Spruce needle oil	1	2	3	2
78	Fizzy drink	1	1	1	1	177	Starch	1	1	1	1
79	Formaldehyde, aq	3	1	3	2	178	Stearic acid	2	4	1	1
80	Formaline	3	1	2	2	179	Sugar, aq	1	1	1	1
81	Formic acid	4	2	4	4	180	Sulfur	1	4	4	1
82	Fruit juice	1	1	1	1	181	Sulfuric acid (concentrated)	4	4	4	4
83	Fuel	1	4	4	2	182	Sulfuric acid (up to 50 %)	4	1	3	2
84	Fuel oil	1	3	4	1	183	Sulfur dioxide, g	1	1	2	3
85	Gin	1	1	2	1	184	Tar (hot tar)	1	3	3	4
86	Glycerine	1	1	1	1	185	Tartaric acid, aq	1	1	1	1
87	Glycol	1	1	1	2	186	Tea	1	1	1	1
88	Heptane	1	1	1	2	187	Tetrahydrofuran	1	3	4	4
89	Hexane	1	1	1	2	188	Tetralin (tetrahydronaphthalene)	1	4	1	2
90	Honey	1	1	1	1	189	Tin dichloride	1	1	1	1
91	Hydrochloric acid (up to 20 %)	4	1	2	2	190	Toluene	1	4	4	4
92	Hydrokloride, g	4	1	2	2	191	Trichloroethylene	2	4	4	4
93	Hydrogen preoxide, aq	2	1	3	2	192	Turpentine (oil of)	1	3	3	4
94	Ink	1	1	1	1	193	Urea, aq	1	1	1	1
95	Isooctane	1	4	1	1	194	Vanilla	1	1	1	1
96	Isoprapanol	1	1	3	3	195	Vaseline	1	3	2	1
97	Jelly	1	1	1	1	196	White spirit	1	4	3	1
98	Lactic acid	2	2	3	3	197	Wine	1	1	1	1
99	Lanolin	1	3	2	1	198	Xylene	1	4	4	4

- 1 Dayanıklı Resistant 2 Genellikle dayanıklı Resistant in general 3 Az dayanıklı Fairly resistant 4 Dayanısız Non-resistant 5 Erimeye maruz kalır Liable to dissolve

Bu tablolar oda şartlarındaki testler ,hammadde tedarikçilerinin tavsiyeleri ve müşterilerimizin tecrübeleriyle hazırlanmıştır. Kullanıcıların farklı şartlardaki uygulamaları ürünlerin verimliliğinde değişik sonuçlar ortaya çıkarabilir. Verilen sonuçlar yaklaşıktır.

This table has been compiled on the basis of in-house tests, the recommendations of our raw material suppliers and customer experiences. Difference in user environments will affect the performance characteristics of the product in different ways. The ratings given above are therefore approximate only.

PNÖMATİK HORTUMLAR

Gapex Polyamid 12 Hortumlar





ÇAP (Dış x İç)	ÜRÜN	RENK SEÇENEKLERİ	FİYAT € / Mt.
3 x 1.5	Polyamid 12 Hortum	● ○	€ 0,183
4 x 2	Polyamid 12 Hortum	●	€ 0,254
4 x 2.5	Polyamid 12 Hortum	● ○	€ 0,217
5 x 3.3	Polyamid 12 Hortum	●	€ 0,292
6 x 3	Polyamid 12 Hortum	●	€ 0,526
6 x 4	Polyamid 12 Hortum	● ○ ● ● ● ●	€ 0,392
6.35 x 4.30	Polyamid 12 Hortum	●	€ 0,432
7 x 5	Polyamid 12 Hortum	●	€ 0,479
7.5 x 3.5	Polyamid 12 Hortum	●	€ 0,857
8 x 4.4	Polyamid 12 Hortum	●	€ 0,857
8 x 5.5	Polyamid 12 Hortum	●	€ 0,649
8 x 6	Polyamid 12 Hortum	● ○ ● ● ● ●	€ 0,540
9 x 6	Polyamid 12 Hortum	●	€ 0,869
9.5 x 6	Polyamid 12 Hortum	●	€ 1,054
9.5 x 7	Polyamid 12 Hortum	●	€ 0,800
10 x 7	Polyamid 12 Hortum	● ○	€ 0,986
10 x 7.5	Polyamid 12 Hortum	●	€ 0,846
10 x 8	Polyamid 12 Hortum	● ○ ●	€ 0,707
11 x 8	Polyamid 12 Hortum	●	€ 1,094
11 x 9	Polyamid 12 Hortum	●	€ 0,800
12 x 9	Polyamid 12 Hortum	● ○ ● ● ● ●	€ 1,216
12.7 x 9	Polyamid 12 Hortum	●	€ 1,540
12 x 10	Polyamid 12 Hortum	● ○	€ 0,857
12.5 x 10	Polyamid 12 Hortum	● ○	€ 1,079
14 x 10	Polyamid 12 Hortum	●	€ 1,842
14 x 11	Polyamid 12 Hortum	●	€ 1,436
15 x 12	Polyamid 12 Hortum	●	€ 1,576
16 x 12	Polyamid 12 Hortum	●	€ 2,143
18 x 14	Polyamid 12 Hortum	●	€ 2,479
20x16	Polyamid 12 Hortum	●	€ 2,742
22x18	Polyamid 12 Hortum	●	€ 3,029

Zelflex Polyamid (HIPL) Hortumlar

Fotoğraf	ÇAP (Dış x İç)	ÜRÜN	FİYAT € / Mt.
	4 x 2 mm	Polyamid HIPL Hortum	€ 0,199
	6 x 4 mm	Polyamid HIPL Hortum	€ 0,311
	8 x 5.5 mm	Polyamid HIPL Hortum	€ 0,519
	8 x 6 mm	Polyamid HIPL Hortum	€ 0,424
	10 x 7.5 mm	Polyamid HIPL Hortum	€ 0,664
	10 x 8 mm	Polyamid HIPL Hortum	€ 0,553
	12 x 9 mm	Polyamid HIPL Hortum	€ 0,947
	14X10mm	Polyamid HIPL Hortum	€ 1,457
	15 x 12 mm	Polyamid HIPL Hortum	€ 1,231
	16 x 12 mm	Polyamid HIPL Hortum	€ 1,690

Gapex Polietilen Hortumlar

Fotoğraf	ÇAP (Dış x İç)	RENK SEÇENEKLERİ	FİYAT \$ / Mt.
 	2 x 4	○ ●	0,135 \$
	3 x 5	● ○ ●	0,155 \$
	4 x 6	● ○ ● ● ● ●	0,172 \$
	4 x 8	●	0,377 \$
	5 x 8	● ●	0,309 \$
	6 x 8	● ○ ● ● ● ●	0,232 \$
	6 x 10	● ○ ●	0,501 \$
	6.5 x 10	● ●	0,470 \$
	8 x 10	● ○ ●	0,309 \$
	8 x 12	● ●	0,592 \$
	9 x 11	○ ● ●	0,346 \$
	9 x 12	○ ●	0,496 \$
	9 x 13	●	0,670 \$
	10 x 12	○ ●	0,382 \$
	10 x 14	●	0,732 \$
	12 x 16	● ● ●	0,870 \$
	4.3 x 6.35 (1/4")	○	0,188 \$
	7 x 9.6 (3/8")	○	0,346 \$
	9 x 12.7 (1/2")	○	0,614 \$

PNÖMATİK HORTUMLAR

PURFLEX (eko)Poliüretan (TPU) Hortumlar (ESTER)

ÇAP (Dış x İç)	RENK SEÇENEKLERİ	FİYAT € / Mt.
2 x 4	○ ●	0,158 €
4 x 6	○ ● ● ●	0,243 €
5 x 8	○ ● ● ●	0,428 €
5.5 x 8	○ ● ● ●	0,375 €
6 x 8	○ ● ● ●	0,328 €
6.5 x 10	○ ● ● ●	0,616 €
7 x 10	○ ●	0,548 €
8 x 10	○ ●	0,419 €
8 x 12	○ ● ● ●	0,843 €
9 x 12	○ ●	0,674 €
10 x 14	○ ●	1,018 €
12 x 16	○ ●	1,188 €



BORU KELEPÇELERİ

Metal + Kaplama Tipi	Gövde Malzemesi
1 Fosfat / Phosphated / Fe/Znph	P "Polipropilen / Polypropylene"
3 "Galvaniz / Galvanised"	A Alüminyum / Aluminum

PP-POLİPROPİLEN / KOMPLE KELEPÇE

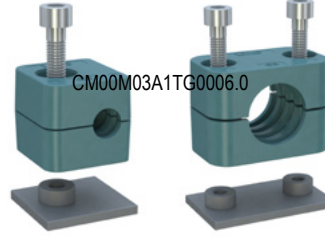

AL-ALÜMİNYUM / KOMPLE KELEPÇE

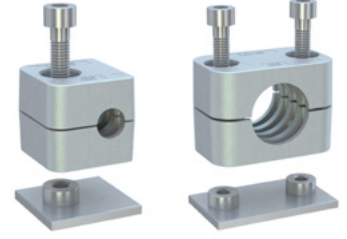

Grup	Dış Çap (mm)	Anma Çapı (inç)	Dış Çap (inç)	Siparis Kodu	DOLAR \$ / ADET
G0 Tek Civatalı	6			CM00M03P1YG0006.0	0,81
	6,4		1/4"	CM00M03P1YG0006.4	
	8		5/16"	CM00M03P1YG0008.0	
	9,5		3/8"	CM00M03P1YG0009.5	
	10	R 1/8		CM00M03P1YG0010.0	
	12			CM00M03P1YG0012.0	
G1	6			CM00M03P1YG1006.0	1,15
	6,4		1/4"	CM00M03P1YG1006.4	
	8		5/16"	CM00M03P1YG1008.0	
	9,5		3/8"	CM00M03P1YG1009.5	
	10	R 1/8		CM00M03P1YG1010.0	
	12			CM00M03P1YG1012.0	
G2	12,7		1/2"	CM00M03P1YG2012.7	1,30
	13,5	R 1/4		CM00M03P1YG2013.5	
	14			CM00M03P1YG2014.0	
	15			CM00M03P1YG2015.0	
	16		5/8"	CM00M03P1YG2016.0	
	17,2	R 3/8		CM00M03P1YG2017.2	
G3	18			CM00M03P1YG2018.0	1,47
	19		3/4"	CM00M03P1YG3019.0	
	20			CM00M03P1YG3020.0	
	21,3	R 1/2		CM00M03P1YG3021.3	
	22		7/8"	CM00M03P1YG3022.0	
	23			CM00M03P1YG3023.0	
G4	25			CM00M03P1YG3025.0	1,69
	25,4		1"	CM00M03P1YG3025.4	
	26,9	R 3/4		CM00M03P1YG4026.9	
	28			CM00M03P1YG4028.0	
	30			CM00M03P1YG4030.0	
	32		1 1/4"	CM00M03P1YG5032.0	
G5	33,7	R 1		CM00M03P1YG5033.7	2,13
	35			CM00M03P1YG5035.0	
	38		1 1/2"	CM00M03P1YG5038.0	
	40			CM00M03P1YG5040.0	
	42	R 1 1/4		CM00M03P1YG5042.0	
	44,5		1 3/4"	CM00M03P1YG6044.5	
G6	48,3	R 1 1/2		CM00M03P1YG6048.3	2,82
	50,8		2"	CM00M03P1YG6050.8	
	57,2		2 1/4"	CM00M03P1YG7057.2	
G6	60,3	R 2		CM00M03P1YG7060.3	6,35
	63,5		2 1/2"	CM00M03P1YG7063.5	
	70		2 3/4"	CM00M03P1YG7070.0	
	73			CM00M03P1YG7073.0	
	76,1	R 2 1/2	3"	CM00M03P1YG7076.1	
G7	88,9	R 3	3 1/2"	CM00M03P1YG8088.9	7,90
	101,6		4"	CM00M03P1YG8101.6	

Katalog Sıra No	1
Siparis Kodu	DOLAR \$ / ADET
CM00M03A1TG0006.0	2,88
CM00M03A1TG0006.4	
CM00M03A1TG0008.0	
CM00M03A1TG0009.5	
CM00M03A1TG0010.0	
CM00M03A1TG0012.0	
CM00M03A1TG1006.0	3,31
CM00M03A1TG1006.4	
CM00M03A1TG008.0	
CM00M03A1TG009.5	
CM00M03A1TG1010.0	
CM00M03A1TG1012.0	
CM00M03A1TG2012.7	3,66
CM00M03A1TG2013.5	
CM00M03A1TG2014.0	
CM00M03A1TG2015.0	
CM00M03A1TG2016.0	
CM00M03A1TG2017.2	
CM00M03A1TG2018.0	3,98
CM00M03A1TG3019.0	
CM00M03A1TG3020.0	
CM00M03A1TG3021.3	
CM00M03A1TG3022.0	
CM00M03A1TG3023.0	
CM00M03A1TG3025.0	5,14
CM00M03A1TG4026.9	
CM00M03A1TG4028.0	
CM00M03A1TG4030.0	
CM00M03A1TG5032.0	
CM00M03A1TG5033.7	
CM00M03A1TG5035.0	7,07
CM00M03A1TG5038.0	
CM00M03A1TG5040.0	
CM00M03A1TG5042.0	
CM00M03A1TG6044.5	
CM00M03A1TG6048.3	
CM00M03A1TG6050.8	9,81
CM00M03A1TG7057.2	
CM00M03A1TG7060.3	
CM00M03A1TG7063.5	
CM00M03A1TG7070.0	
CM00M03A1TG7073.0	
CM00M03A1TG7076.1	Sorunuz
CM00M03A1TG8088.9	
CM00M13A1TG8101.6	

BORU KELEPÇELERİ

Metal + Kaplama Tipi	Gövde Malzemesi
1 Fosfat / Phosphated / Fe/Znph	P "Polipropilen / Polypropylene"
3 "Galvaniz / Galvanised"	A Alüminyum / Aluminum

PP-POLİPROPİLEN / AĞIR SERİ KOMPLE KELEPÇE

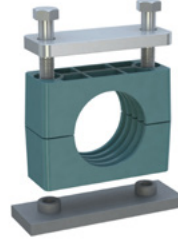

Grup	Dış Çap (mm)	Anma Çapı (inç)	Dış Çap (inç)	Siparis Kodu	DOLAR \$ / ADET
A1	6			CM40M13P1YA1006.0	5,14
	6,4		1/4"	CM40M13P1YA1006.4	
	8		5/16"	CM40M13P1YA1008.0	
	9,5		3/8"	CM40M13P1YA1009.5	
	10	R 1/8"		CM40M13P1YA1010.0	
	12			CM40M13P1YA1012.0	
	12,7		1/2"	CM40M13P1YA1012.7	
	13,5	R 1/4"		CM40M13P1YA1013.5	
	14			CM40M13P1YA1014.0	
	15			CM40M13P1YA1015.0	
	16		5/8"	CM40M13P1YA1016.0	
	17,2	R 3/8"		CM40M13P1YA1017.2	
	18			CM40M13P1YA1018.0	
	A2	19		3/4"	
20				CM40M13P1YA2020.0	
21,3		R 1/2"		CM40M13P1YA2021.3	
22			7/8"	CM40M13P1YA2022.0	
25				CM40M13P1YA2025.0	
25,4			1"	CM40M13P1YA2025.4	
26,9		R 3/4"		CM40M13P1YA2026.9	
28				CM40M13P1YA2028.0	
A3	30			CM40M13P1YA2030.0	6,64
	30			CM40M13P1YA3030.0	
	32		1 1/4"	CM40M13P1YA3032.0	
	33,7	R 1"		CM40M13P1YA3033.7	
	35			CM40M13P1YA3035.0	
	38		1 1/2"	CM40M13P1YA3038.0	
A4	40			CM40M13P1YA3040.0	13,92
	42	R 1 1/4"		CM40M13P1YA3042.0	
	38		1 1/2"	CM40M13P1YA4038.0	
	42	R 1 1/4"		CM40M13P1YA4042.0	
	44,5		1 3/4"	CM40M13P1YA4044.5	
	48,3	R 1 1/2"		CM40M13P1YA4048.3	
	50,8		2"	CM40M13P1YA4050.8	
	55			CM40M13P1YA4055.0	
	57		2 1/4"	CM40M13P1YA4057.0	
	60,3	R 2"		CM40M13P1YA4060.3	
63,5		2 1/2"	CM40M13P1YA4063.5		
65			CM40M13P1YA4065.0		
70		2 3/4"	CM40M13P1YA4070.0		

Metal + Kaplama Tipi	Gövde Malzemesi
1 Fosfat / Phosphated / Fe/Znph	P "Polipropilen / Polypropylene"
3 "Galvaniz / Galvanised"	A Alüminyum / Aluminum

PP-POLİPROPİLEN / AĞIR SERİ KOMPLE KELEPÇE

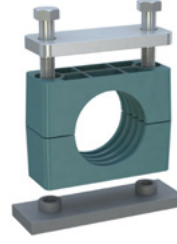

Katalog Sıra No	23
-----------------	----

Grup	Dış Çap (mm)	Anma Çapı (inç)	Dış Çap (inç)	Siparis Kodu	DOLAR \$ / ADET
A5	65			CM40M13P1YA5065.0	29,35
	70			CM40M13P1YA5070.0	
	73	R 2 1/2"	2 7/8	CM40M13P1YA5073.0	
	76,1	R 2 1/2"	3	CM40M13P1YA5076.1	
	80			CM40M13P1YA5080.0	
	82,5		3 1/4"	CM40M13P1YA5082.5	
	88,9	R 3"	3 1/2"	CM40M13P1YA5088.9	
A6	88,9	R 3"	3 1/2"	CM40M13P1YA6088.9	77,23
	100			CM40M13P1YA6100.0	
	101,6	R 3 1/2"		CM40M13P1YA6101.6	
	108		4 1/4"	CM40M13P1YA6108.0	
	114,3	R 4"		CM40M13P1YA6114.3	
	127		5"	CM40M13P1YA6127.0	
	133		5 1/4"	CM40M13P1YA6133.0	
A7	133		5 1/4"	CM40M13P1YA7133.0	115,49
	139,7	R 5"		CM40M13P1YA7139.7	
	152,4		6"	CM40M13P1YA7152.4	
	159		6 1/4"	CM40M13P1YA7159.0	
	165		6 1/2"	CM40M13P1YA7165.0	
	168,3	R 6"		CM40M13P1YA7168.3	
A8	168,3	R 6"		CM40M13P1YA8168.3	Sorunuz
	177,8		7"	CM40M13P1YA8177.8	
	193,7		7 5/8"	CM40M13P1YA8193.7	
	216		8 1/2"	CM40M13P1YA8216.0	
	219,1	R 8"		CM40M13P1YA8219.1	
A9	219,1	R 8"		CM40M13P1YA9219.1	Sorunuz
	244,5			CM40M13P1YA9244.5	
	273	R 10"		CM40M13P1YA9273.0	
	323,9	R 12"		CM40M13P1YA9323.9	
A10	355,6	R 14"		CM40M13P1YA0355.6	Sorunuz
	406,4	R 16"		CM40M13P1YA0406.4	

BORU KELEPÇELERİ

Metal + Kaplama Tipi	Gövde Malzemesi
1 Fosfat / Phosphated / Fe/Znph	P "Polipropilen / Polypropylene"
3 "Galvaniz / Galvanised"	A Alüminyum / Aluminum

PP-POLİPROPİLEN / İKİZ SERİ KOMPLE KELEPÇE

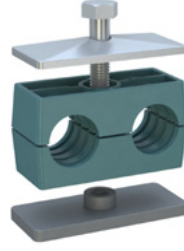

Katalog Sıra No

43

Grup	Dış Çap (mm)	Anma Çapı (inç)	Dış Çap (inç)	Siparis Kodu	DOLAR \$ / ADET
I1	6			CM40M13P1YI1006.0	1,17
	6,4		1/4"	CM40M13P1YI1006.4	
	8		5/16"	CM40M13P1YI1008.0	
	9,5		3/8"	CM40M13P1YI1009.5	
	10	R 1/8"		CM40M13P1YI1010.0	
	12			CM40M13P1YI1012.0	
I2	12,7		1/2"	CM40M13P1YI2012.7	1,97
	13,5	R 1/4"		CM40M13P1YI2013.5	
	14			CM40M13P1YI2014.0	
	15			CM40M13P1YI2015.0	
	16		5/8"	CM40M13P1YI2016.0	
	17,2	R 3/8"		CM40M13P1YI2017.2	
	18			CM40M13P1YI2018.0	
I3	19		3/4"	CM40M13P1YI3019.0	2,46
	20			CM40M13P1YI3020.0	
	21,3	R 1/2"		CM40M13P1YI3021.3	
	22		7/8"	CM40M13P1YI3022.0	
	23			CM40M13P1YI3023.0	
	25			CM40M13P1YI3025.0	
	25,4		1"	CM40M13P1YI3025.4	
I4	26,9	R 3/4"		CM40M13P1YI4026.9	2,92
	28			CM40M13P1YI4028.0	
	30			CM40M13P1YI4030.0	
I5	32		1 1/4"	CM40M13P1YI5032.0	3,67
	33,7	1"		CM40M13P1YI5033.7	
	35			CM40M13P1YI5035.0	
	38		1 1/2"	CM40M13P1YI5038.0	
	40			CM40M13P1YI5040.0	
	42	R 1 1/4"		CM40M13P1YI5042.0	

A worker in a yellow safety vest and orange pants is holding a traffic cone. The worker is standing on a paved surface, and a piece of machinery is visible in the background. The image is overlaid with a semi-transparent white box containing the text.

BORU BAĞLANTILARI

FIRETECH



KURTMAN A.Ş.

BORU BAĞLANTILARI



Metrik Somun

Seri	Boru Çapı(mm)	Kod	Ürün Adı	Diş Ölçüsü	TL/Ad	Kutu/Ad
L Tipi	6	102220612	S6NB	M12x1,5	24,52	100
	8	102220814	S8NB	M14x1,5	28,02	100
	10	102221016	S10NB	M16x1,5	33,86	100
	12	102221218	S12NB	M18x1,5	36,19	100
	15	102221522	S15NB	M22x1,5	52,53	50
	18	102221826	S18NB	M26x1,5	81,71	50
	22	102222230	S22NB	M30x2	103,89	25
	28	102222836	S28NB	M36x2	161,09	25
	35	102223545	S35NB	M45x2	201,94	10
	42	102224252	S42NB	M52x2	403,88	10
S Tipi	6	102320614	S6YB	M14x1,5	37,36	100
	8	102320816	S8YB	M16x1,5	42,03	100
	10	102321018	S10YB	M18x1,5	46,70	100
	12	102321220	S12YB	M20x1,5	47,86	100
	14	102321422	S14YB	M22x1,5	93,39	50
	16	102321624	S16YB	M24x1,5	80,55	50
	20	102322030	S20YB	M30x2	109,73	25
	25	102322536	S25YB	M36x2	172,76	25
	30	102323042	S30YB	M42x2	201,94	10
	38	102323852	S38YB	M52x2	461,08	10

Hortum Somun



Seri	Boru Çapı(mm)	Kod	Ürün Adı	M	TL/Ad	Kutu/Ad
L Tipi	6	107220612	HS06NB	M12x1,5	Fiyat Sorunuz	100
	8	107220814	HS08NB	M14x1,5		100
	10	107221016	HS10NB	M16x1,5		100
	12	107221218	HS12NB	M18x1,5		100
	15	107221522	HS15NB	M22x1,5		50
S Tipi	16	107321624	HS16YB	M24x1,5		50



24° Metrik Düz Nipel

Seri	Boru Çapı(mm)	Kod	Ürün Adı	Diş Ölçüsü	TL/Ad	Kutu/Ad
L Tipi	6	X121200606	XN6NB	M12x1,5	64,49	100
	8	X121200808	XN8NB	M14x1,5	67,12	100
	10	X121201010	XN10NB	M16x1,5	72,36	100
	12	X121201212	XN12NB	M18x1,5	76,53	100
	15	X121201515	XN15NB	M22x1,5	89,37	50
	18	X121201818	XN18NB	M26x1,5	234,45	50
	22	X121202222	XN22NB	M30x2	257,72	25
	28	X121202828	XN28NB	M36x2	398,37	25
	35	X121203535	XN35NB	M45x2	443,73	10
	42	X121204242	XN42NB	M52x2	519,51	10
S Tipi	6	X121300606	XN6YB	M14x1,5	83,25	100
	8	X121300808	XN8YB	M16x1,5	89,28	100
	10	X121301010	XN10YB	M18x1,5	93,42	100
	12	X121301212	XN12YB	M20x1,5	102,09	100
	14	X121301414	XN14YB	M22x1,5	246,50	50
	16	X121301616	XN16YB	M24x1,5	170,22	50
	20	X121302020	XN20YB	M30x2	200,23	25
	25	X121302525	XN25YB	M36x2	316,08	25
		30	X121303030	XN30YB	M42x2	440,55
	38	X121303838	XN38YB	M52x2	802,76	10



Metrik 24° Dirsek

Seri	Boru Çapı(mm)	Kod	Ürün Adı	Diş Ölçüsü	TL/Ad	Kutu/Ad
L Tipi	6	X122200606	XD6NB	M12x1,5	214,52	100
	8	X122200808	XD8NB	M14x1,5	219,60	100
	10	X122201010	XD10NB	M16x1,5	233,55	100
	12	X122201212	XD12NB	M18x1,5	243,43	100
	15	X122201515	XD15NB	M22x1,5	299,97	50
	18	X122201818	XD18NB	M26x1,5	418,82	50
	22	X122202222	XD22NB	M30x2	450,61	25
	28	X122202828	XD28NB	M36x2	700,25	25
	35	X122203535	XD35NB	M45x2	907,11	10
	42	X122204242	XD42NB	M52x2	1.309,50	10
S Tipi	6	X122300606	XD6YB	M14x1,5	286,05	100
	8	X122300808	XD8YB	M16x1,5	254,79	100
	10	X122301010	XD10YB	M18x1,5	300,51	100
	12	X122301212	XD12YB	M20x1,5	317,39	100
	14	X122301414	XD14YB	M22x1,5	482,24	50
	16	X122301616	XD16YB	M24x1,5	341,28	50
	20	X122302020	XD20YB	M30x2	454,14	25
	25	X122302525	XD25YB	M36x2	708,35	25
		30	X122303030	XD30YB	M42x2	896,04
	38	X122303838	XD38YB	M52x2	1.284,21	10

BORU BAĞLANTILARI



Metrik 24° Tee

Seri	Boru Çapı(mm)	Kod	Ürün Adı	Diş Ölçüsü	TL/Ad	Kutu/Ad
L Tipi	6	X123200606	XT6NB	M12x1,5	292,66	100
	8	X123200808	XT8NB	M14x1,5	292,32	100
	10	X123201010	XT10NB	M16x1,5	273,67	100
	12	X123201212	XT12NB	M18x1,5	301,19	100
	15	X123201515	XT15NB	M22x1,5	416,5	50
	18	X123201818	XT18NB	M26x1,5	503,87	50
	22	X123202222	XT22NB	M30x2	567,93	25
	28	X123202828	XT28NB	M36x2	834,71	25
	35	X123203535	XT35NB	M45x2	1112,22	10
	42	X123204242	XT42NB	M52x2	1.727,46	10
S Tipi	6	X123300606	XT6YB	M14x1,5	321,84	100
	8	X123300808	XT8YB	M16x1,5	316,17	100
	10	X123301010	XT10YB	M18x1,5	349,14	100
	12	X123301212	XT12YB	M20x1,5	383,31	100
	14	X123301414	XT14YB	M22x1,5	674,67	50
	16	X123301616	XT16YB	M24x1,5	462,06	50
	20	X123302020	XT20YB	M30x2	605,86	25
	25	X123302525	XT25YB	M36x2	842,83	25
	30	X123303030	XT30YB	M42x2	1.175,43	10
	38	X123303838	XT38YB	M52x2	1.729,89	10

Yüksük



Seri	Boru Çapı(mm)	Kod	Ürün Adı	TL/Ad
L/S Tipi	6	101200600	Y6NB/YB	22,18
	8	101200800	Y8NB/YB	24,52
	10	101201000	Y10NB/YB	33,86
	12	101201200	Y12NB/YB	36,19
L Tipi	15	101201500	Y15NB	50,20
	18	101201800	Y18NB	71,21
	22	101202200	Y22NB	103,89
	28	101202800	Y28NB	150,58
	35	101203500	Y35NB	267,31
	42	101204200	Y42NB	353,69
S Tipi	14	101301400	Y14YB	58,50
	16	101301600	Y16YB	58,37
	20	101302000	Y20YB	100,39
	25	101302500	Y25YB	143,58
	30	101303000	Y30YB	203,11
	38	101303800	Y38YB	365,36



BSP Blok-Metrik 24° Rakor

Seri	Boru Çapı(mm)	Blok Tarafı	Kod	Ürün Adı	TL/Ad	Kutu/Ad
L Tipi	6	G1/8"	X501210602	XRE6NBR02PLX	58,10	100
		G1/4"	X501210604	XRE6NBR04PLX	77,47	100
	8	G1/8"	X501210802	XRE8NBR02PLX	62,94	100
		G1/4"	X501210804	XRE8NBR04PLX	65,37	100
		G3/8"	X501210806	XRE8NBR06PLX	87,12	100
	10	G1/4"	X501211004	XRE10NBR04PLX	70,2	100
		G3/8"	X501211006	XRE10NBR06PLX	82,31	100
		G1/2"	X501211008	XRE10NBR08PLX	116,19	50
	12	G1/4"	X501211204	XRE12NBR04PLX	70,20	100
		G3/8"	X501211206	XRE12NBR06PLX	82,31	100
		G1/2"	X501211208	XRE12NBR08PLX	116,19	50
	15	G1/2"	X501211508	XRE15NBR08PLX	121,05	50
	18	G1/2"	X501211808	XRE18NBR08PLX	125,87	50
		G3/4"	X501211812	XRE18NBR12PLX	169,45	25
	22	G3/4"	X501212212	XRE22NBR12PLX	169,45	25
	28	G1"	X501212816	XRE28NBR16PLX	314,69	25
	35	G1"	X501213516	XRE35NBR16PLX	411,51	10
		G1 1/4"	X501213520	XRE35NBR20PLX	459,93	10
42	G1 1/4"	X501214220	XRE42NBR20PLX	605,16	10	
	G1 1/2"	X501214224	XRE42NBR24PLX	605,16	10	
S Tipi	6	G1/4"	X501310604	XRE6YBR04PLX	82,31	100
	8	G1/4"	X501310804	XRE8YBR04PLX	82,31	100
	10	G1/4"	X501311004	XRE10YBR04PLX	82,31	100
		G3/8"	X501311006	XRE10YBR06PLX	106,52	100
		G1/2"	X501311008	XRE10YBR08PLX	169,45	50
	12	G1/4"	X501311204	XRE12YBR04PLX	106,52	100
		G3/8"	X501311206	XRE12YBR06PLX	96,82	100
		G1/2"	X501311208	XRE12YBR08PLX	130,71	50
	14	G1/2"	X501311408	XRE14YBR08PLX	169,82	50
	16	G3/8"	X501311606	XRE16YBR06PLX	135,54	50
		G1/2"	X501311608	XRE16YBR08PLX	121,05	50
		G3/4"	X501311612	XRE16YBR12PLX	174,29	25
	20	G1/2"	X501312008	XRE20YBR08PLX	179,13	25
		G3/4"	X501312012	XRE20YBR12PLX	174,29	25
		G1"	X501312016	XRE20YBR16PLX	324,36	25
	25	G3/4"	X501312512	XRE25YBR12PLX	324,36	25
		G1"	X501312516	XRE25YBR16PLX	324,36	25
	30	G1"	X501313016	XRE30YBR16PLX	411,51	10
G1 1/4"		X501313020	XRE30YBR20PLX	484,11	10	
38	G1 1/4"	X501313820	XRE38YBR20PLX	605,16	10	
	G1 1/2"	X501313824	XRE38YBR24PLX	605,16	10	

BORU BAĞLANTILARI

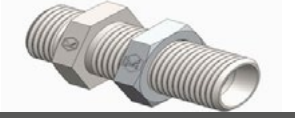

Perde Geçiş Nipel

Seri	Boru Çapı(mm)	Kod	Ürün Adı	Diş Ölçüsü	TL/Ad	Kutu/Ad
L Tipi	6	X181200606	XPGN6NB	M12x1,5	154,94	100
	8	X181200808	XPGN8NB	M14x1,5	154,94	100
	10	X181201010	XPGN10NB	M16x1,5	154,94	100
	12	X181201212	XPGN12NB	M18x1,5	174,29	100
	15	X181201515	XPGN15NB	M22x1,5	222,71	50
	18	X181201818	XPGN18NB	M26x1,5	314,69	50
	22	X181202222	XPGN22NB	M30x2	435,69	25
	28	X181202828	XPGN28NB	M36x2	726,17	25
	35	X181203535	XPGN35NB	M45x2	871,41	10
	42	X181204242	XPGN42NB	M52x2	1307,10	10
S Tipi	6	X181300606	XPGN6YB	M14x1,5	203,34	100
	8	X181300808	XPGN8YB	M16x1,5	203,34	100
	10	X181301010	XPGN10YB	M18x1,5	203,34	100
	12	X181301212	XPGN12YB	M20x1,5	227,52	100
	14	X181301414	XPGN14YB	M22x1,5	535,02	50
	16	X181301616	XPGN16YB	M24x1,5	314,69	50
	20	X181302020	XPGN20YB	M30x2	474,42	25
	25	X181302525	XPGN25YB	M36x2	677,75	25
	30	X181303030	XPGN30YB	M42x2	871,41	10
	38	X181303838	XPGN38YB	M52x2	1.452,33	10

Perde Geçiş Dirseği



Seri	Boru Çapı(mm)	Kod	Ürün Adı	Diş Ölçüsü	TL/Ad	Kutu/Ad
L Tipi	6	X183200606	XPGD6NB	M12x1,5	336,04	100
	8	X183200808	XPGD8NB	M14x1,5	344,97	100
	10	X183201010	XPGD10NB	M16x1,5	359,51	100
	12	X183201212	XPGD12NB	M18x1,5	408,24	100
	15	X183201515	XPGD15NB	M22x1,5	542,93	50
	18	X183201818	XPGD18NB	M26x1,5	671,00	50
	22	X183202222	XPGD22NB	M30x2	860,88	25
	28	X183202828	XPGD28NB	M36x2	1.292,67	25
	35	X183203535	XPGD35NB	M45x2	3.559,42	10
	42	X183204242	XPGD42NB	M52x2	4.181,97	10
S Tipi	6	X183300606	XPGD6YB	M14x1,5	481,64	100
	8	X183300808	XPGD8YB	M16x1,5	486,03	100
	10	X183301010	XPGD10YB	M18x1,5	468,99	100
	12	X183301212	XPGD12YB	M20x1,5	440,62	100
	14	X183301414	XPGD14YB	M22x1,5	764,40	50
	16	X183301616	XPGD16YB	M24x1,5	571,71	50
	20	X183302020	XPGD20YB	M30x2	810,25	25
	25	X183302525	XPGD25YB	M36x2	1.292,67	25
	30	X183303030	XPGD30YB	M42x2	3.505,40	10
	38	X183303838	XPGD38YB	M52x2	4.181,97	10

BSPT Blok(Konik)-Metrik 24° Dirsek



Seri	Boru Çapı(mm)	Blok Tarafı	Kod	Ürün Adı	TL/Ad	Kutu/Ad
L Tipi	6	R1/8"	X161250602	XEDD6NBR02	165,90	100
		R1/4"	X161250604	XEDD6NBR04	239,85	100
	8	R1/8"	X161250802	XEDD8NBR02	244,89	100
		R1/4"	X161250804	XEDD8NBR04	260,17	100
		R3/8"	X161250806	XEDD8NBR06	268,77	100
	10	R1/4"	X161251004	XEDD10NBR04	260,17	100
		R3/8"	X161251006	XEDD10NBR06	268,77	100
		R1/2"	X161251008	XEDD10NBR08	299,97	50
	12	R1/4"	X161251204	XEDD12NBR04	268,77	100
		R3/8"	X161251206	XEDD12NBR06	268,77	100
		R1/2"	X161251208	XEDD12NBR08	299,97	50
	15	R1/2"	X161251508	XEDD15NBR08	299,97	50
	18	R1/2"	X161251808	XEDD18NBR08	375,15	50
	22	R3/4"	X161252212	XEDD22NBR12	962,63	25
	28	R1"	X161252816	XEDD28NBR16	651,22	25
35	R 1 1/4"	X161253520	XEDD35NBR20	1.084,28	10	
42	R 1 1/2"	X161254224	XEDD42NBR24	1.537,25	10	
S Tipi	6	R1/4"	X161350604	XEDD6YBR04	293,47	100
	8	R1/4"	X161350804	XEDD8YBR04	260,17	100
	10	R3/8"	X161351006	XEDD10YBR06	268,77	100
	12	R3/8"	X161351206	XEDD12YBR06	302,22	100
		R1/2"	X161351208	XEDD12YBR08	299,97	50
	16	R3/8"	X161351606	XEDD16YBR06	341,28	25
		R1/2"	X161351608	XEDD16YBR08	313,43	25
	20	R1/2"	X161352008	XEDD20YBR08	468,81	10
		R3/4"	X161352012	XEDD20YBR12	468,81	10
	25	R3/4"	X161352512	XEDD25YBR12	683,06	50
		R1"	X161352516	XEDD25YBR16	684,61	50
	30	R1"	X161353016	XEDD30YBR16	896,04	25
		R1 1/4"	X161353020	XEDD30YBR20	896,04	25
	38	R1 1/2"	X161353824	XEDD38YBR24	1.456,27	10

BORU BAĞLANTILARI

BSP Blok-Döner Dirsek

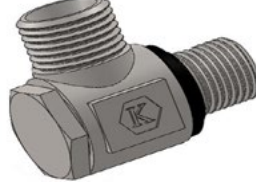

Seri	Boru Çapı(mm)	Blok Tarafı	Kod	Ürün Adı	TL/Ad	Kutu/Ad
L Tipi	6	G1/8"	X206210602	XDD6NBR02KDS	442,62	100
		G1/4"	X206210604	XDD6NBR04KDS	466,07	100
	8	G1/4"	X206210804	XDD8NBR04KDS	510,44	100
	10	G1/4"	X206211004	XDD10NBR04KDS	466,07	100
	12	G3/8"	X206211206	XDD12NBR06KDS	571,68	100
	15	G1/2"	X206211508	XDD15NBR08KDS	720,81	50
	18	G1/2"	X206211808	XDD18NBR08KDS	720,81	50
	22	G3/4"	X206212212	XDD22NBR12KDS	958,39	25
	28	G1"	X206212816	XDD28NBR16KDS	1.638,07	25
	35	G1 1/4"	X206213520	XDD35NBR20KDS	2.559,51	10
	42	G1 1/2"	X206214224	XDD42NBR24KDS	3.649,35	10
	S Tipi	6	G1/4"	X206310604	XDD6YBR04KDS	545,85
8		G1/4"	X206310804	XDD8YBR04KDS	520,56	100
10		G3/8"	X206311006	XDD10YBR06KDS	607,1	100
12		G3/8"	X206311206	XDD12YBR06KDS	607,10	100
14		G1/2"	X206311408	XDD14YBR08KDS	1.420,54	50
16		G1/2"	X206311608	XDD16YBR08KDS	720,81	50
20		G3/4"	X206312012	XDD20YBR12KDS	958,39	25
25		G1"	X206312516	XDD25YBR16KDS	1.678,57	25
38		G1 1/2"	X206313824	XDD38YBR24KDS	3.952,02	10



Yan Bacak Ters Tee (Pimli)

Seri	Boru Çapı(mm)	Kod	Ürün Adı	Diş Ölçüsü	TL/Ad	Kutu/Ad
L tipi	6	X516200606	XYTP6NB12	M12x1,5	359,80	100
	8	X516200808	XYTP8NB14	M14x1,5	359,08	100
	10	X516201010	XYTP10NB16	M16x1,5	357,08	100
	12	X516201212	XYTP12NB18	M18x1,5	378,81	100
	15	X516201515	XYTP15NB22	M22x1,5	489,51	50
	18	X516201818	XYTP18NB26	M26x1,5	602,87	50
	22	X516202222	XYTP22NB30	M30x2	714,15	25
	28	X516202828	XYTP28NB36	M36x2	1.082,95	25
	35	X516203535	XYTP35NB45	M45x2	1.516,86	10
	42	X516204242	XYTP42NB52	M52x2	2.164,59	10
S Tipi	6	X516300606	XYTP6YB14	M14x1,5	437,67	100
	8	X516300808	XYTP8YB16	M16x1,5	446,63	100
	10	X516301010	XYTP10YB18	M18x1,5	468,59	100
	12	X516301212	XYTP12YB20	M20x1,5	484,61	100
	14	X516301414	XYTP14YB22	M22x1,5	947,67	50
	16	X516301616	XYTP16YB24	M24x1,5	558,9	50
	20	X516302020	XYTP20YB30	M30x2	763,16	25
	25	X516302525	XYTP25YB36	M36x2	1.109,19	25
	30	X516303030	XYTP30YB42	M42x2	1.630,15	10
	38	X516303838	XYTP38YB52	M52x2	2.301,6	10



Orta Bacak Ters Tee (Pimli)

Seri	Boru Çapı(mm)	Kod	Ürün Adı	Diş Ölçüsü	TL/Ad	Kutu/Ad
L tipi	6	X522220612	XOTP6NB12	M12x1,5	359,80	100
	8	X522220814	XOTP8NB14	M14x1,5	359,08	100
	10	X522221016	XOTP10NB16	M16x1,5	357,08	100
	12	X522221218	XOTP12NB18	M18x1,5	378,81	100
	15	X522221522	XOTP15NB22	M22x1,5	489,51	50
	18	X522221826	XOTP18NB26	M26x1,5	602,87	50
	22	X522222230	XOTP22NB30	M30x2	714,15	25
	28	X522222836	XOTP28NB36	M36x2	1.082,95	25
	35	X522223545	XOTP35NB45	M45x2	1.516,86	10
	42	X522224252	XOTP42NB52	M52x2	2.164,59	10
S Tipi	6	X522320614	XOTP6YB14	M14x1,5	437,67	100
	8	X522320816	XOTP8YB16	M16x1,5	446,63	100
	10	X522321018	XOTP10YB18	M18x1,5	468,59	100
	12	X522321220	XOTP12YB20	M20x1,5	484,61	100
	14	X522321422	XOTP14YB22	M22x1,5	947,67	50
	16	X522321624	XOTP16YB24	M24x1,5	558,90	50
	20	X522322030	XOTP20YB30	M30x2	763,16	25
	25	X522322536	XOTP25YB36	M36x2	1.109,19	25
	30	X522323042	XOTP30YB42	M42x2	1.630,15	10
	38	X522323852	XOTP38YB52	M52x2	2.301,60	10

BORU BAĞLANTILARI

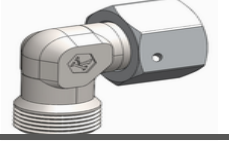

Ters Dirsek Pimli

Seri	Boru Çapı(mm)	Kod	Ürün Adı	Diş Ölçüsü	TL/Ad	Kutu/Ad
L tipi	06	X513200606	XTDP6NB	M12x1,5	291,63	100
	08	X513200808	XTDP8NB	M14x1,5	283,50	100
	10	X513201010	XTDP10NB	M16x1,5	299,14	100
	12	X513201212	XTDP12NB	M18x1,5	307,40	100
	15	X513201515	XTDP15NB	M22x1,5	394,38	50
	18	X513201818	XTDP18NB	M26x1,5	514,65	50
	22	X513202222	XTDP22NB	M30x2	606,31	25
	28	X513202828	XTDP28NB	M36x2	948,42	25
	35	X513203535	XTDP35NB	M45x2	1.311,75	10
	42	X513204242	XTDP42NB	M52x2	1.764,43	10
S Tipi	06	X513300606	XTDP6YB	M14x1,5	368,67	100
	08	X513300808	XTDP8YB	M16x1,5	379,65	100
	10	X513301010	XTDP10YB	M18x1,5	375,57	100
	12	X513301212	XTDP12YB	M20x1,5	393,35	100
	14	X513301414	XTDP14YB	M22x1,5	893,44	50
	16	X513301616	XTDP16YB	M24x1,5	444,02	50
	20	X513302020	XTDP20YB	M30x2	593,51	25
	25	X513302525	XTDP25YB	M36x2	984,11	25
	30	X513303030	XTDP30YB	M42x2	1.350,77	10
	38	X513303838	XTDP38YB	M52x2	1.855,87	10



BSP Blok - Metrik 24° Ters Rakor (Pimli)

Seri	Boru Çapı(mm)	Blok Tarafı	Kod	Ürün Adı	TL/Ad	Kutu/Ad
	8	G1/4"	512210804	TREP8NBR04PLX	157,10	100
	10	G1/4"	512211004	TREP10NBR04PLX	151,52	100
	12	G3/8"	512211206	TREP12NBR06PLX	181,69	100
	15	G1/2"	512211508	TREP15NBR08PLX	250,18	50
	18	G1/2"	512211808	TREP18NBR08PLX	278,19	50
	22	G3/4"	512212212	TREP22NBR12PLX	351,09	25
	28	G1"	512212816	TREP28NBR16PLX	655,83	25
	35	G1 1/4"	512213520	TREP35NBR20PLX	904,93	10
	42	G1 1/2"	512214224	TREP42NBR24PLX	1.151,46	10
	S Tipi	6	G1/4"	512310604	TREP6YBR04PLX	163,85
8		G1/4"	512310804	TREP8YBR04PLX	167,92	100
10		G3/8"	512311006	TREP10YBR06PLX	195,17	100
12		G3/8"	512311206	TREP12YBR06PLX	200,07	100
14		G1/2"	512311408	TREP14YBR08PLX	577,11	50
16		G1/2"	512311608	TREP16YBR08PLX	268,70	50
20		G3/4"	512312012	TREP20YBR12PLX	376,95	25
25		G1"	512312516	TREP25YBR16PLX	642,02	25
30		G1 1/4"	512313020	TREP30YBR20PLX	975,51	10
38		G1 1/2"	512313824	TREP38YBR24PLX	1.237,68	10



BSP Redüksiyon

Kod	Ürün Adı	TL/Ad	Kutu/Ad
506010402	RD1/4"-1/8"PLX	86,13	100
506010602	RD3/8"-1/8"PLX	72,77	100
506010604	RD3/8"-1/4"PLX	106,92	50
506010804	RD1/2"-1/4"PLX	103,95	25
506010806	RD1/2"-3/8"PLX	103,95	50
506011204	RD3/4"-1/4"PLX	165,88	25
506011206	RD3/4"-3/8"PLX	121,77	25
506011208	RD3/4"-1/2"PLX	121,77	25
506011604	RD1"-1/4"PLX	338,58	25
506011608	RD1"-1/2"PLX	288,09	25
506011612	RD1"-3/4"PLX	288,09	25
506012012	RD11/4"-3/4"PLX	415,8	10
506012016	RD11/4"-1"PLX	415,8	10
506012416	RD11/2"-1"PLX	490,05	10
506012420	RD11/2"-11/4"PLX	490,05	10

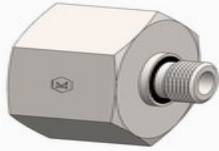

BSP Lüle - L/PLX

Kod	Ürün Adı	TL/Ad	Kutu/Ad
507010204	L1/8"-1/4"PLX	86,13	100
507010206	L1/8"-3/8"PLX	234,03	100
507010406	L1/4"-3/8"PLX	106,92	100
507010408	L1/4"-1/2"PLX	193,05	50
507010608	L3/8"-1/2"PLX	243,54	50
507010612	L3/8"-3/4"PLX	291,06	25
507010812	L1/2"-3/4"PLX	311,85	25
507010820	L1/2"-11/4"PLX	1006,53	10
507011216	L3/4"-1"PLX	386,10	25
507011220	L3/4"-11/4"PLX	623,70	10
507011620	L1"-11/4"PLX	623,70	10
507011624	L1"-11/2"PLX	831,60	10
507012024	L11/4"-11/2"PLX	831,60	10

BORU BAĞLANTILARI



BSP Allen Başlı Kör Tapa

Diş Ölçüsü	Kod	Ürün Adı	TL/Ad	Kutu/Ad
G1/8"	510010202	ALKT1/8"PLX	35,89	100
G1/4"	510010404	ALKT1/4"PLX	48,47	100
G3/8"	510010606	ALKT3/8"PLX	56,55	100
G1/2"	510010808	ALKT1/2"PLX	75,51	50
G3/4"	510011212	ALKT3/4"PLX	97,23	25
G1"	510011616	ALKT1"PLX	133,38	25
G1 1/4"	510012020	ALKT11/4"PLX	348,57	10
G1 1/2"	510012424	ALKT11/2"PLX	363,11	10



Metrik Allen Başlı Kör Tapa

Diş Ölçüsü	Kod	Ürün Adı	TL/Ad	Kutu/Ad
M10x1	511021010	ALKTM10PLX	40,77	100
M12x1,5	511021212	ALKTM12PLX	52,34	100
M14x1,5	511021414	ALKTM14PLX	54,54	100
M16x1,5	511021616	ALKTM16PLX	63,07	100
M18x1,5	511021818	ALKTM18PLX	65,88	50
M20x1,5	511022020	ALKTM20PLX	75,76	50
M22x1,5	511022222	ALKTM22PLX	77,52	50
M26x1,5	511022626	ALKTM26PLX	133,97	25
M33x2	511023333	ALKTM33PLX	322,73	25
M42x2	511024242	ALKTM42PLX	443,98	10
M48x2	511024848	ALKTM48PLX	597,50	10



BSP Manşon

Diş Ölçüsü	Kod	Ürün Adı	TL/Ad	Kutu/Ad
G1/8"	301010202	MA1/8"	55,51	100
G1/4"	301010404	MA1/4"	66,83	100
G3/8"	301010606	MA3/8"	73,13	100
G1/2"	301010808	MA1/2"	112,21	50
G3/4"	301011212	MA3/4"	151,2	50
G1"	301011616	MA1"	245,55	25
G1 1/4"	301012020	MA11/4"	391,14	25
G1 1/2"	301012424	MA11/2"	442,58	10

BSP Körtapa



Diş Ölçüsü	Kod	Ürün Adı	TL/Ad	Kutu/Ad
G1/8"	321010202	KT1/8"	44,04	100
G1/4"	321010404	KT1/4"	50,58	100
G3/8"	321010606	KT3/8"	57,49	100
G1/2"	321010808	KT1/2"	79,63	50
G3/4"	321011212	KT3/4"	115,83	50
G1"	321011616	KT1"	266,27	25
G1 1/4"	321012020	KT11/4"	356,4	25
G1 1/2"	321012424	KT11/2"	460,35	10

BSP Düz Nipel



Diş Ölçüsü	Kod	Ürün Adı	TL/Ad	Kutu/Ad
G1/8"	302140202	DN30-1/8"	62,94	100
G1/4"	302140404	DN30-1/4"	82,31	100
G3/8"	302140606	DN30-3/8"	91,98	100
G1/2"	302140808	DN30-1/2"	159,75	50
G3/4"	302141212	DN30-3/4"	227,52	50
G1"	302141616	DN30-1"	338,88	25
G1 1/4"	302142020	DN30-11/4"	484,11	25
G1 1/2"	302142424	DN30-11/2"	556,74	10

BSP Orantılı Nipel - ODZN

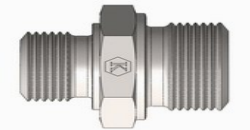

Diş Ölçüsü	Kod	Ürün Adı	TL/Ad	Kutu/Ad
G1/8"-G1/4"	310010402	ODZN1/4"-1/8"	87,12	100
G1/4"-G3/8"	310010604	ODZN3/8"-1/4"	91,98	100
G1/4"-G1/2"	310010804	ODZN1/2"-1/4"	159,75	100
G3/8"-G1/2"	310010806	ODZN1/2"-3/8"	159,75	100
G1/2"-G3/4"	310011208	ODZN3/4"-1/2"	193,64	100
G3/4"-G1"	310011612	ODZN1"-3/4"	401,81	50
G3/4"-G1 1/4"	310012012	ODZN11/4"-3/4"	580,93	25
G3/4"-G1 1/2"	310012412	ODZN11/2"-3/4"	930,32	10
G1"-G1 1/4"	310012016	ODZN11/4"-1"	605,16	25
G1"-G1 1/2"	310012416	ODZN11/2"-1"	966,33	10
G1 1/4"-G1 1/2"	310012420	ODZN11/2"-11/4"	653,56	10

BORU BAĞLANTILARI

BSP Dişi Dirsek



Diş Ölçüsü	Kod	Ürün Adı	TL/Ad	Kutu/Ad
G1/8"	303010202	IDD1/8"	253,08	100
G1/4"	303010404	IDD1/4"	232,88	100
G3/8"	303010606	IDD3/8"	253,08	100
G1/2"	303010808	IDD1/2"	353,97	50
G3/4"	303011212	IDD3/4"	465,75	50
G1"	303011616	IDD1"	729,68	25
G1 1/4"	303012020	IDD11/4"	1.263,74	25
G1 1/2"	303012424	IDD11/2"	2.629,94	10

BSP Dişi TEE



Diş Ölçüsü	Kod	Ürün Adı	TL/Ad	Kutu/Ad
G1/8"	304010202	IDT1/8"	310,5	100
G1/4"	304010404	IDT1/4"	319,82	100
G3/8"	304010606	IDT3/8"	378,81	100
G1/2"	304010808	IDT1/2"	512,33	50
G3/4"	304011212	IDT3/4"	807,3	50
G1"	304011616	IDT1"	1.055,7	25
G1 1/4"	304012020	IDT11/4"	1.769,85	25
G1 1/2"	304012424	IDT11/2"	4.978,91	10

BSPT Kuyruklu Dirsek

Fotoğraf	Diş Ölçüsü	Kod	Ürün Adı	TL/Ad	Kutu/Ad
	G1/8"	307010202	KYD1/8"	282,81	100
	G1/4"	307010404	KYD1/4"	269,85	100
	G3/8"	307010606	KYD3/8"	301,77	100
	G1/2"	307010808	KYD1/2"	448,09	50
	G3/4"	307011212	KYD3/4"	654,71	50
	G1"	307011616	KYD1"	931,5	25
	G1 1/4"	307012020	KYD11/4"	1.380,36	25

Manometre Bağlantı Rakoru



Seri	Boru Çapı(mm)	Blok Tarafı	Kod	Ürün Adı	TL/Ad	Kutu/Ad
L Tipi	6	G1/4"	X263210604	XMBR6NBR04	96,17	100
	8		X263210804	XMBR8NBR04	96,17	100
	10		X263211004	XMBR10NBR04	91,94	100
	12		X263211204	XMBR12NBR04	96,78	100
S Tipi	6	G1/2"	X263310608	XMBR6YBR08	242,85	100
	8		X263310808	XMBR8YBR08	242,85	100
	10		X263311008	XMBR10YBR08	242,85	100
	12		X263311208	XMBR12YBR08	362,41	100

Manometre Halkası



Seri	Boru Çapı(mm)	Blok Tarafı	Kod	Ürün Adı	TL/Ad	Kutu/Ad
L Tipi	6-8-10-12	1/4"	363210404	MH1/4"	36,33	100
S Tipi	6-8-10-12	1/2"	363310808	MH1/2"	50,57	100

Metrik 24° Kaynaklı Rakor



Seri	Boru Çapı(mm)	Kod	Ürün Adı	Diş Ölçüsü	TL/Ad	Kutu/Ad
L Tipi	6	X281200600	XKRE6NB	M12x1,5	125,31	100
	8	X281200800	XKRE8NB	M14x1,5	153,96	100
	10	X281201000	XKRE10NB	M16x1,5	168,71	100
	12	X281201200	XKRE12NB	M18x1,5	169,73	100
	15	X281201500	XKRE15NB	M22x1,5	227,36	50
	18	X281201800	XKRE18NB	M26x1,5	281,74	50
	22	X281202200	XKRE22NB	M30x2	360,69	25
	28	X281202800	XKRE28NB	M36x2	510,19	25
	35	X281203500	XKRE35NB	M45x2	642,27	10
	42	X281204200	XKRE42NB	M52x2	860,99	10
S Tipi	6	X281300600	XKRE6YB	M14x1,5	156,33	100
	8	X281300800	XKRE8YB	M16x1,5	169,82	100
	10	X281301000	XKRE10YB	M18x1,5	197,36	100
	12	X281301200	XKRE12YB	M20x1,5	197,60	100
	14	X281301400	XKRE14YB	M22x1,5	253,09	50
	16	X281301600	XKRE16YB	M24x1,5	306,14	50
	20	X281302000	XKRE20YB	M30x2	504,16	25
	25	X281302500	XKRE25YB	M36x2	543,85	25
	30	X281303000	XKRE30YB	M42x2	693,09	10
	38	X281303800	XKRE38YB	M52x2	945,73	10

Metrik 24° Kaynaklı Dirsek



Seri	Boru Çapı(mm)	Kod	Ürün Adı	Diş Ölçüsü	TL/Ad	Kutu/Ad
L Tipi	6	X282200600	XKD6NB	M12x1,5	233,91	100
	8	X282200800	XKD8NB	M14x1,5	238,28	100
	10	X282201000	XKD10NB	M16x1,5	248,25	100
	12	X282201200	XKD12NB	M18x1,5	253,29	100
	15	X282201500	XKD15NB	M22x1,5	325,13	50
	18	X282201800	XKD18NB	M26x1,5	409,77	50
	22	X282202200	XKD22NB	M30x2	610,45	25
	28	X282202800	XKD28NB	M36x2	832,46	25
	35	X282203500	XKD35NB	M45x2	1.101,69	10
	42	X282204200	XKD42NB	M52x2	1.574,06	10
S Tipi	6	X282300600	XKD6YB	M14x1,5	274,67	100
	8	X282300800	XKD8YB	M16x1,5	341,84	100
	10	X282301000	XKD10YB	M18x1,5	371,01	100
	12	X282301200	XKD12YB	M20x1,5	303,53	100
	14	X282301400	XKD14YB	M22x1,5	469,28	50
	16	X282301600	XKD16YB	M24x1,5	324,63	50
	20	X282302000	XKD20YB	M30x2	610,45	25
	25	X282302500	XKD25YB	M36x2	731,25	25
	30	X282303000	XKD30YB	M42x2	1.089,68	10
	38	X282303800	XKD38YB	M52x2	1.574,06	10

BORU BAĞLANTILARI

Kuyruklu Yüksük



Seri	Boru Çapı(mm)	Kod	Ürün Adı	TL/Ad	Kutu/Ad
L/S Tipi	6	508000600	KYO6NB/YB	87,98	100
	8	508000800	KYO8NB/YB	87,98	100
	10	508001000	KYO10NB/YB	93,83	100
	12	508001200	KYO12NB/YB	93,83	100
L Tipi	15	508201500	KYO15NB	140,72	50
	18	508201800	KYO18NB	175,91	50
	22	508202200	KYO22NB	211,10	25
	28	508202800	KYO28NB	293,20	25
	35	508203500	KYO35NB	351,86	10
	42	508204200	KYO42NB	527,76	10
S Tipi	14	508301400	KYO14YB	165,18	50
	16	508301600	KYO16YB	152,46	50
	20	508302000	KYO20YB	187,68	25
	25	508302500	KYO25YB	269,73	25
	30	508303000	KYO30YB	328,41	10
	38	508303800	KYO38YB	527,76	10

Körleme Tapası O'ringli



Seri	Boru Çapı(mm)	Kod	Ürün Adı	TL/Ad	Kutu/Ad
L Tipi	6	X505200600	XTAPO6NB	31,22	100
	8	X505200800	XTAPO8NB	77,56	100
	10	X505201000	XTAPO10NB	39,71	100
	12	X505201200	XTAPO12NB	92,63	100
	15	X505201500	XTAPO15NB	56,89	50
	18	X505201800	XTAPO18NB	160,13	50
	22	X505202200	XTAPO22NB	155,77	25
	28	X505202800	XTAPO28NB	197,21	25
	35	X505203500	XTAPO35NB	358,74	10
	42	X505204200	XTAPO42NB	409,86	10
S Tipi	6	X505200600	XTAPO6YB	31,22	100
	8	X505200800	XTAPO8YB	77,56	100
	10	X505201000	XTAPO10YB	39,71	100
	12	X505201200	XTAPO12YB	92,63	100
	14	X505301400	XTAPO14YB	111,62	50
	16	X505301600	XTAPO16YB	110,19	50
	20	X505302000	XTAPO20YB	112,13	25
	25	X505302500	XTAPO25YB	141,48	25
	30	X505303000	XTAPO30YB	273,21	10
	38	X505303800	XTAPO38YB	418,23	10

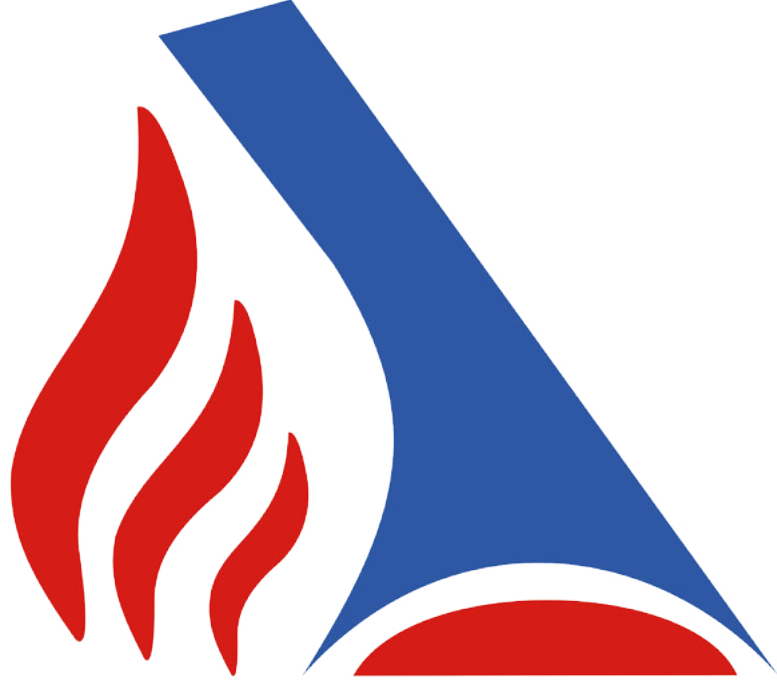

ATEŞ

www.atesas.com.tr

*Ateş AŞ, bu katalogdaki fiyat ve içeriklerde değişiklik yapma hakkına sahiptir.
Baskıdan doğabilecek hatalardan firmamız sorumlu değildir.*